

# BROADCAST NEWS

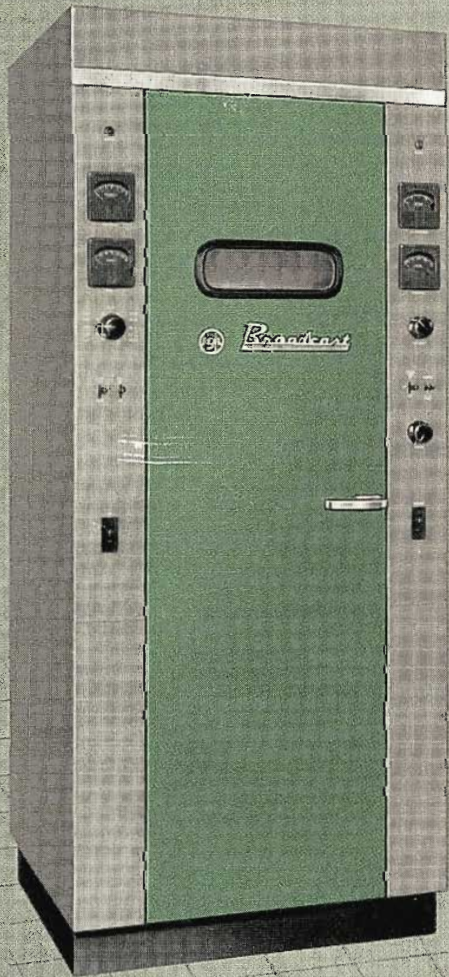

NEW AM TRANSMITTERS  
FEATURE IMPROVED SOUNDABILITY  
AND COLOR STYLING

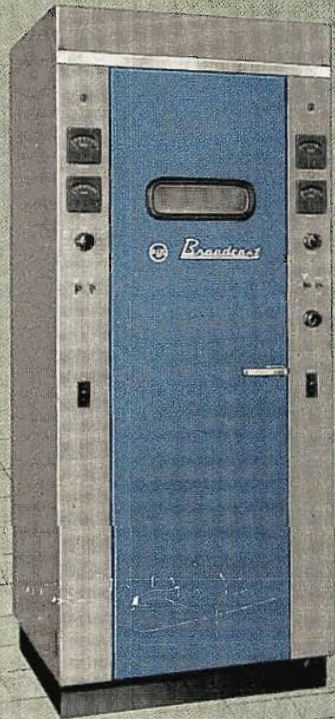

**VOL. No. 100**  
**APRIL 1958**

ASSURING THE MOST FOR YOUR EQUIPMENT DOLLAR

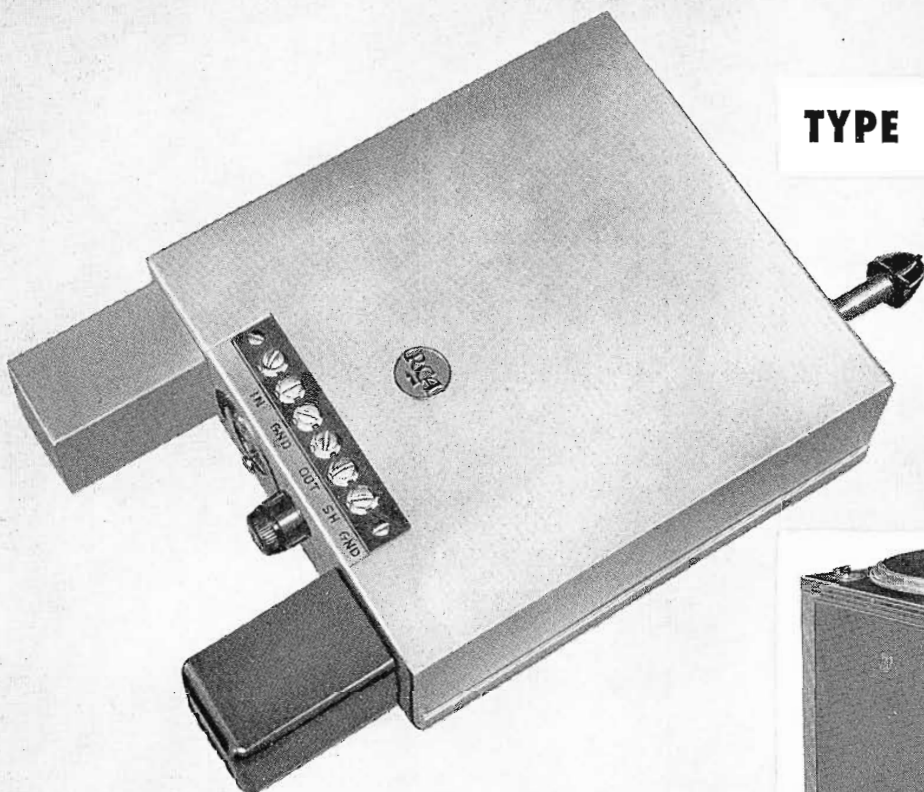

**TYPE BA-26A**

**TRANSISTORIZED**

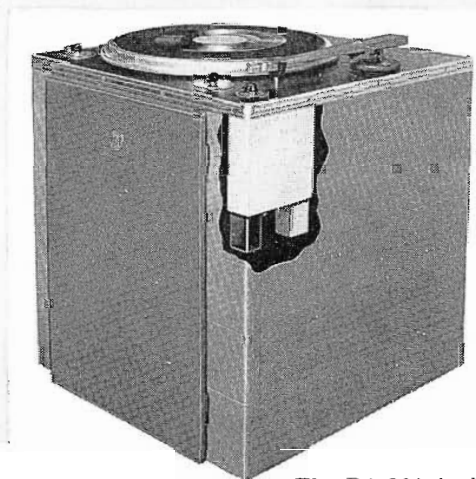

## TURNTABLE EQUALIZING PREAMPLIFIER

The BA-26A is designed to mount in same position and space previously occupied by RCA Type MI-11877 passive equalizer.

***Designed to provide both amplification and equalization of turntable output!***

This compact equipment makes a modern replacement for bulkier combinations of separate amplifier and equalizing filters. Designed to provide both amplification and equalization of output of studio transcription turntables employing either the RCA Type MI-11874-4 or RCA Type MI-11874-5 Pickup Heads. The entire unit is completely self-contained including a-c power supply. Built-in equalization conforms to new industry standards of both NAB

and RIAA. A three position switch compensates for variations in transcriptions and records. Etched wiring circuits provide stable, trouble-free operation. Transistors are employed throughout to assure freedom from microphonics. Absence of inductances make the BA-26 insensitive to stray hum field pickup, greatly simplifying installation. Mounts easily in turntable, provides essentially noise-free operation and long equipment life.

*For full particulars about the new BA-26A Transistorized Turntable Equalizing Preamplifier, see your RCA Broadcast Representative. In Canada: RCA Victor Company, Limited, Montreal.*



**RADIO CORPORATION of AMERICA**

BROADCAST AND TELEVISION EQUIPMENT

CAMDEN, N. J.

Vol. No. 100

April, 1958

# BROADCAST NEWS

*published by*

**RADIO CORPORATION OF AMERICA**  
**BROADCAST & TELEVISION EQUIPMENT DEPARTMENT**  
**CAMDEN, NEW JERSEY**

**PRICE**  
*In U.S.A. - - - \$4.00 for 12 issues*  
*In Canada - - - \$5.00 for 12 issues*

## CONTENTS

	Page
HOW THE RCA VIDEO TAPE RECORDER WORKS . . . . .	6
PROGRESSIVE STEPS TOWARD TV AUTOMATION . . . . .	14
WTPA-TV MAKES CONVERSION FROM 12 TO 25-KW TRANSMITTER FOR MEGAWATT OPERATION . . . . .	18
WFIL-TV AND WRCV-TV MULTIPLE ANTENNA SYSTEM . . . . .	26
THE APPLICATION OF VERY PRECISE FREQUENCY CONTROL . . . . .	32
NEW 500 AND 1000 WATT AM TRANSMITTERS . . . . .	36
KBKC REVEALS ITS MODERN APPROACH TO RADIO . . . . .	44
HOW TO DESIGN THE COMBINATION CONTROL ROOM-ANNOUNCE BOOTH TO GIVE GOOD ACOUSTICAL PERFORMANCE . . . . .	52
THE NEW BK-10A BIGRADIENT UNIAXIAL MICROPHONE . . . . .	56
NEW 2-KW VHF TELEVISION TRANSMITTER . . . . .	58
WIP GETS NEW 5-KW TRANSMITTER . . . . .	63
UNIVERSAL COAXIAL TRANSMISSION LINES . . . . .	64
GROUND WEATHER RADAR FOR BROADCAST STATIONS . . . . .	69

# How to Get Coverage

## with RCA Transmitter-Antenna Combinations

**FOR OVER-ALL UNIFORM COVERAGE**



### 10 KW TRANSMITTER with 12-Section Antenna

An RCA TT-10AL Transmitter for low-channel operation, used with a TF-12AL Antenna for channels 2 and 3 or a TF-12AM for channels 4 to 6.

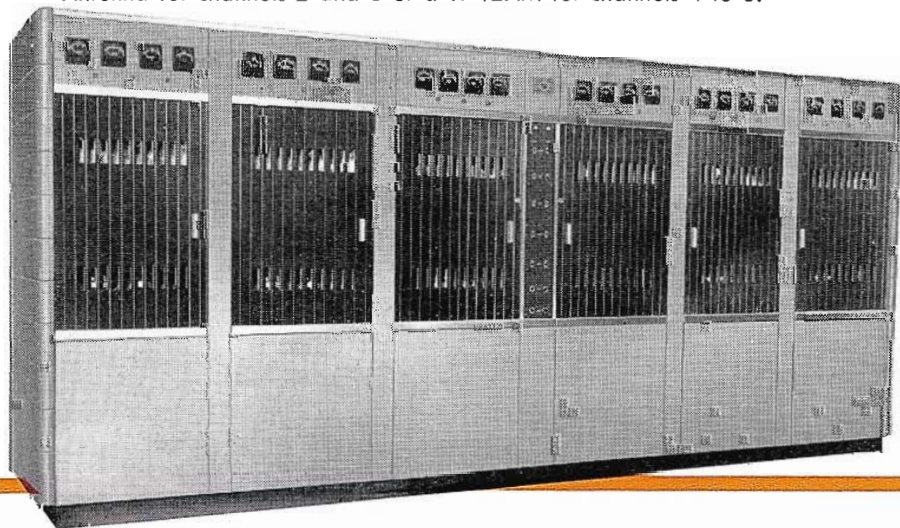

#### *The above combination assures:*

- More uniform coverage . . . without wasting it.
- Low operating cost.
- Minimum space requirements.

#### *Other combinations:*

In locations where ERP is limited by antenna height, a number of combinations can be provided utilizing RCA Transmitters with powers from 2 KW to 25 KW and RCA Antennas with gains from 3 to 12.

# Where It Counts!

for Maximum Power... **LOW BAND**



**FOR CLOSE-IN SATURATION COVERAGE**

## 25 KW TRANSMITTER with 6-Section Antenna

An RCA TT-25CL Transmitter for low-channel operation used with a TF-6AL Antenna for channels 2 and 3 or a TF-6BM for channels 4 to 6.



*The above combination assures:*

Close-in saturation coverage.

Low operating cost.

Reserve power . . . extended tube life.

Whether for low-band or high-band operation, RCA Transmitter-Antenna combinations are available to suit your requirements.

Ask your RCA Representative. In Canada: RCA VICTOR Company Limited, Montreal.



Tmk(s) ®

**RADIO CORPORATION of AMERICA**

BROADCAST AND TELEVISION EQUIPMENT

CAMDEN, N. J.



**Type BK-1A Pressure Microphone**—High-fidelity "Commentator" pressure microphone, non-directional in character. An ideal announce mike for speakers. It assures clear, crisp speech and is well suited for remote pickup.



**Type BK-5A Uniaxial Microphone with Desk Stand**—Standard of the television industry, highly directional, with high front to back ratio. Unidirectional characteristic simplifies microphone and camera placement. (See boom-type below.)



**Type 77-DX Polydirectional Microphone**—Excellent for both voice and music. The standard of the broadcast industry. Variety of directional characteristics, with high sensitivity over entire frequency range, assures high quality reproduction.

# A Microphone

## Immediately Available from RCA!

Whatever your special microphone requirements, RCA can meet them exactly.

Look at the variety of models now offered. You can get pressure-type microphones—such as the BK-1A, SK-45, or BK-6B—and velocity-types—the BK-5A, 77-DX or SK-46. There are microphones for radio or TV station use; for intercom, paging, or PA use. Also mikes for announce, music, or both; for desk, boom, personal use—unidirectional, bidirectional, polydirectional.



**Type BK-5A Uniaxial Microphone with Boom Mount.** Specially engineered for the television industry to reduce camera noise and interference. Newly designed boom mount combines superior mechanical isolation with rugged durability. Also available with wind screen for outdoor use.

## Also A Complete Line of Microphone Accessories...

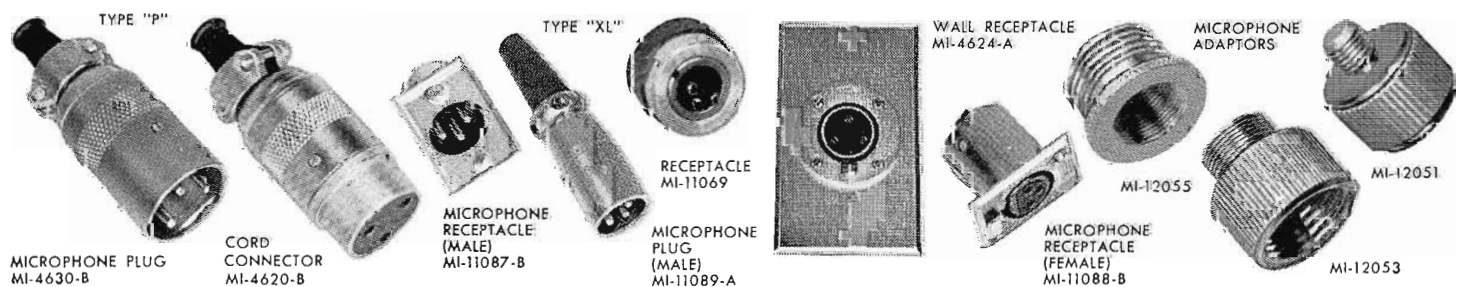

TYPE "P"  
MICROPHONE PLUG  
MI-4630-B

CORD CONNECTOR  
MI-4620-B

MICROPHONE RECEPTACLE (MALE)  
MI-11087-B

TYPE "XL"  
RECEPTACLE PLUG (MALE)  
MI-11089-A

WALL RECEPTACLE  
MI-4624-A

MICROPHONE RECEPTACLE (FEMALE)  
MI-11088-B

MICROPHONE ADAPTORS  
MI-12055

MI-12051  
MI-12053

The advent of the RCA Video Tape Recorder has been long awaited. Its advantages over film for immediate playback and re-use of the raw stock speak for themselves. Moreover, the quality of the picture is much closer to that of the original live presentation. Not the least of its numerous conveniences lies in the relief from chemical processing; furthermore the video tape recorder is relatively simple to operate. To this impressive list of advantages, the RCA Video Tape Recorder has added a number of additional features:

1. Rack mounting, for ease of maintenance;
2. Master erase head which obviates the necessity of using a bulk eraser;
3. Tape-footage counter, for use in logging the exact position of any recording on the reel;
4. Continuously variable rewind/fast forward speed control for ease of cuing;
5. Cue channel, for voice or special control signals;
6. Edit pulses facilitate the splicing of tape;
7. Special signal monitoring facilities for operational reliability;
8. Remote control of operating functions.

The RCA Video Tape Recorder has been designed for both color and monochrome, having had the ultimate use always in view. Color is not an added accessory. Nevertheless, if so desired, the RCA Video Tape Recorder may be obtained without the color processing rack—which then provides a high fidelity monochrome recorder. To this may be added, at any time, the color processing equipment.

#### Basic Recording Principles

The RCA Video Tape Recorder will record and immediately play back a color or monochrome television signal along with program sound with a quality that closely approaches that of the original signal. The tape speed is 15 inches per second and a standard 12½-inch reel will provide 64 minutes of recording time. A one hour recorded program will play back in one hour plus or minus a fraction of a second.

The storage medium is 2-inch wide magnetic tape made of 0.001-inch thick mylar base with a 0.0003-inch magnetic oxide coating. At the time of tape manufacture the magnetic particles are oriented in the transverse direction, i.e., across the width of the tape. This transverse orientation gives a playback signal level about 6 db higher than if the tape had longitudinal orientation.

Figure 1 pictures the actual tracks recorded by the video tape machine. The recorded tape was immersed in a volatile suspension of very fine carbonyl iron particles, whereupon, the iron particles adhered to the magnetized areas. The tape was pulled out and after it had dried, the iron particles were lifted off onto a piece of transparent adhesive tape. This resulted in a permanent display of the recorded tracks. The transverse video tracks can be seen very clearly; the thin white transverse areas being the separation between successive tracks. The program audio track is on the left; the control track and cue track on the right.

The signal in the video tracks is a frequency modulated one. The FM signal deviation is roughly 5 to 6 mc. This is a vestigial sideband signal. Because of the unusual nature of this FM signal, there is some amplitude modulation present. This AM accounts for the fact that the horizontal sync pulses and vertical blanking interval can be seen in Fig. 1. By using FM in the recording and playback process any tape signal amplitude variations are limited out.

The mechanism for recording transverse video tracks involves a 2-inch diameter wheel with four magnetic heads spaced 90

# VIDEO TAPE RECORDER WORKS

by JEROME L. GREVER, *Broadcast and Television Engineering*

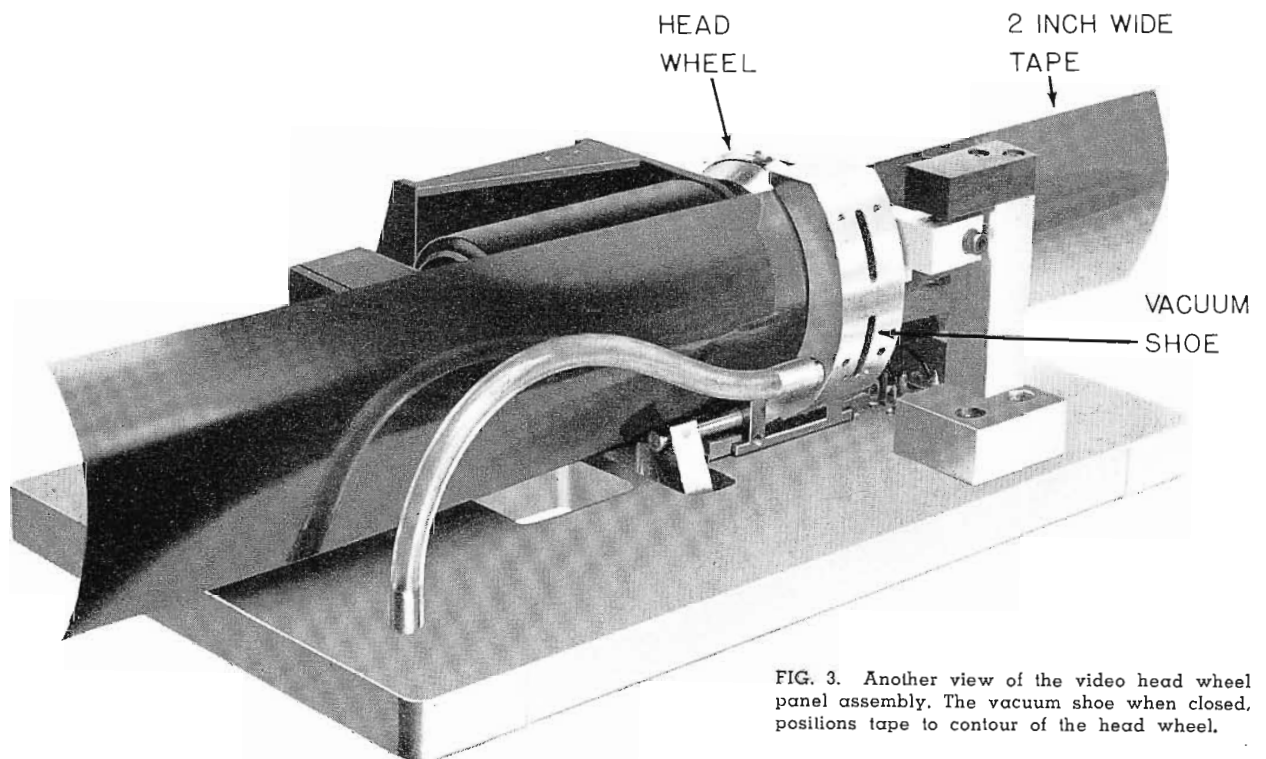

FIG. 3. Another view of the video head wheel panel assembly. The vacuum shoe when closed, positions tape to contour of the head wheel.

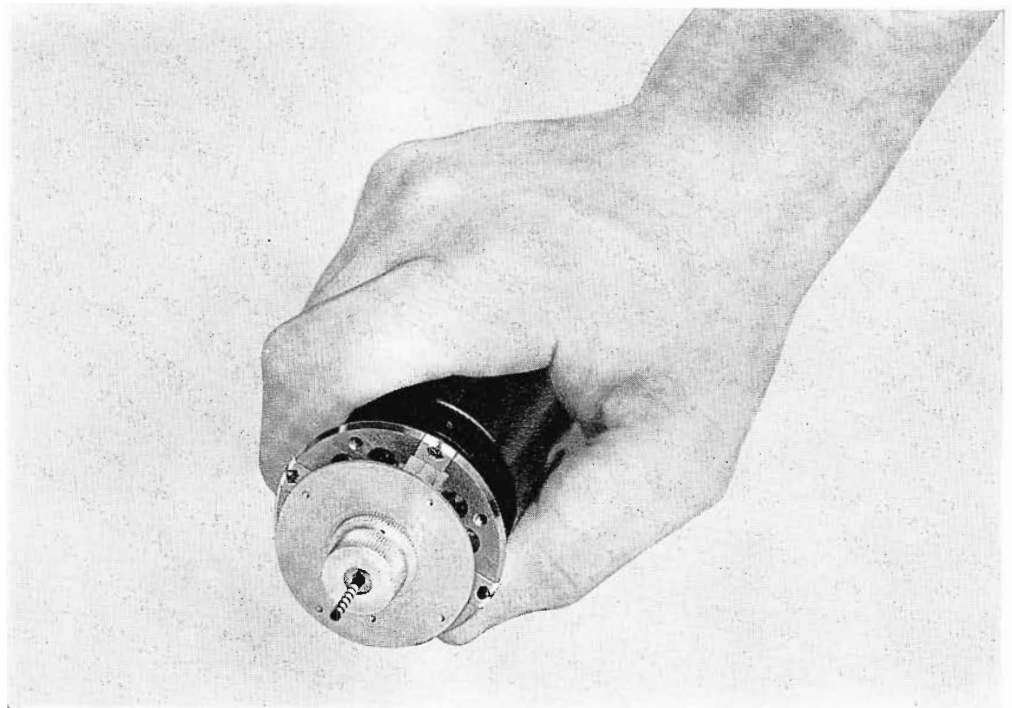
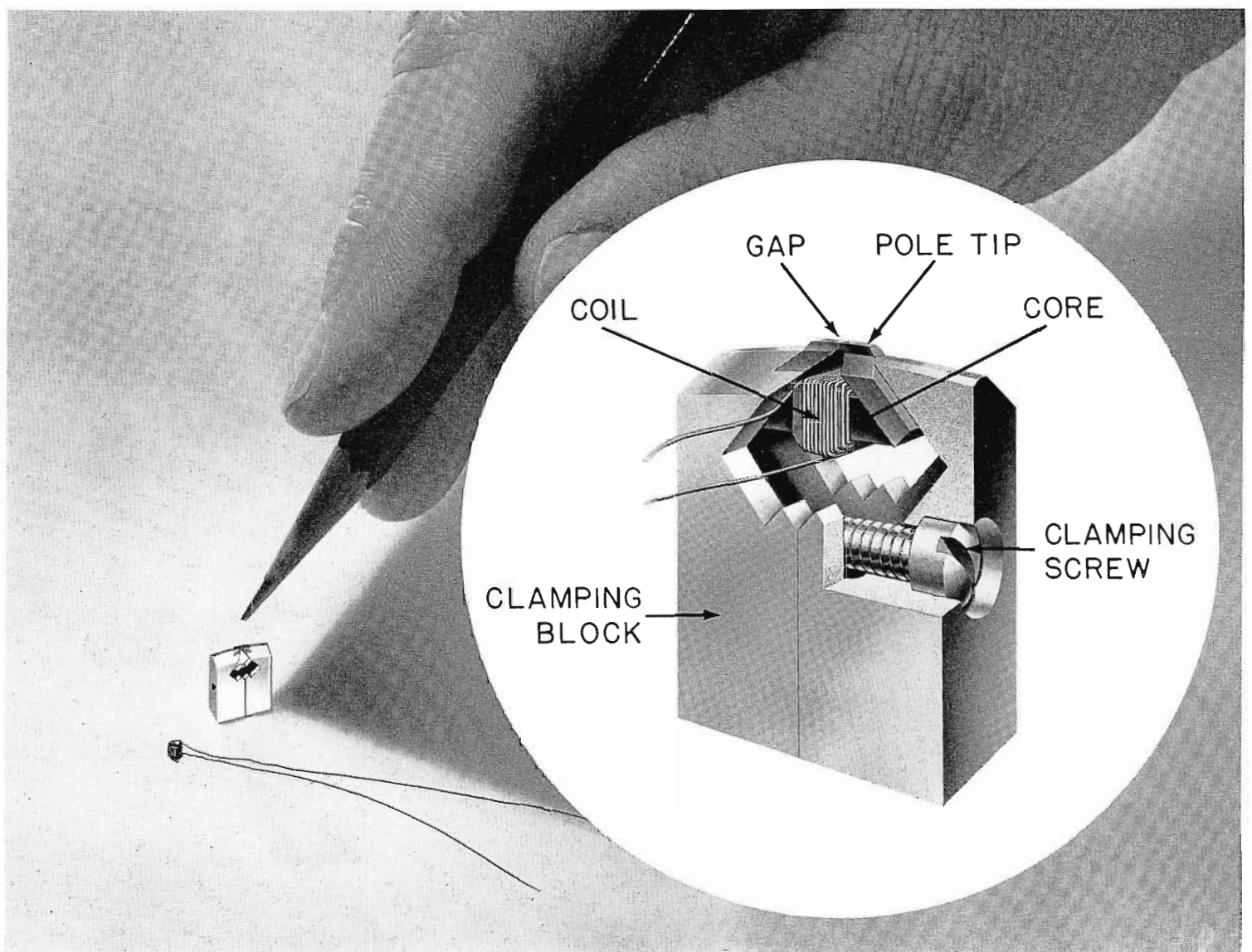
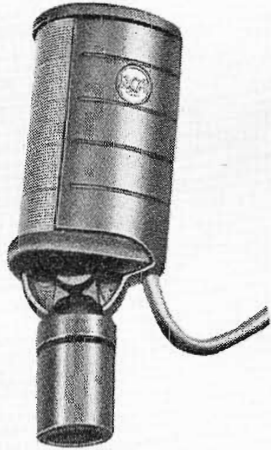

FIG. 4. Close-up of the video head wheel. Four video recording heads are located 90 degrees apart around the head wheel.

FIG. 5. Cutaway view showing details of a video recording head. Note size of head block, core and coil as compared with pencil.







**Type SK-45 Pressure Microphone**—Rugged, announce microphone of the dynamic type, suitable for talk-back or cue-in purposes. Economical, light in weight, small in size. Designed for high or low impedance use.

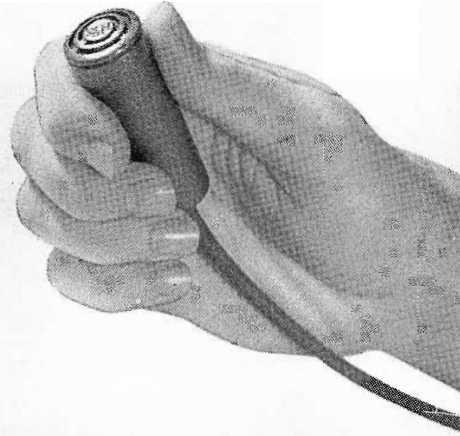

**Type BK-6B Miniature Microphone**—Small but tough, this new personal microphone is easily concealed in hand or clothing. Only half the size and weight of previous models. Offers excellent speech balance when talking "off mike." Wide range frequency response.



**Type SK-46 Velocity Microphone**—Good low-cost studio velocity microphone for speech or music. Provides bidirectional characteristic over wide frequency range. Designed for high or low impedance use.

# for Every Need...

For the finest microphones that money can buy, or for quality, low-cost, utility microphones... when you come to RCA, you know the microphone will be right—whatever the type. It has to reflect the standards for which the RCA symbol has long been famous.

... available for immediate delivery. All represent today's greatest microphone values. For information concerning any of the microphones illustrated, write today for descriptive literature. Bulletins describing desk stands, floor stands, and booms, also available.

Ask your RCA Broadcast Sales Representative



**RADIO CORPORATION of AMERICA**

BROADCAST AND TELEVISION EQUIPMENT

CAMDEN, N. J.

Tmk(s) ®

In Canada: RCA VICTOR Company Limited, Montreal

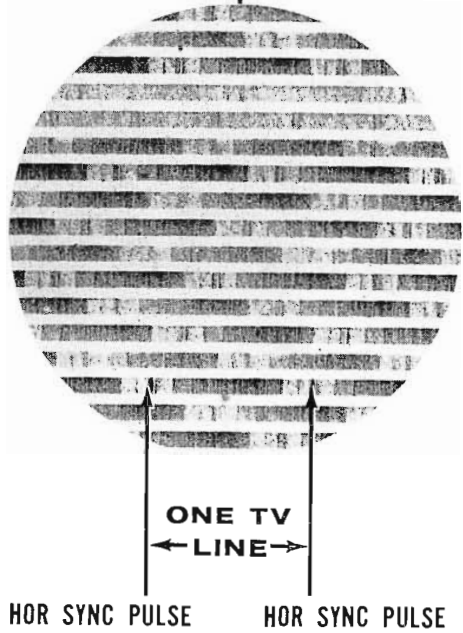
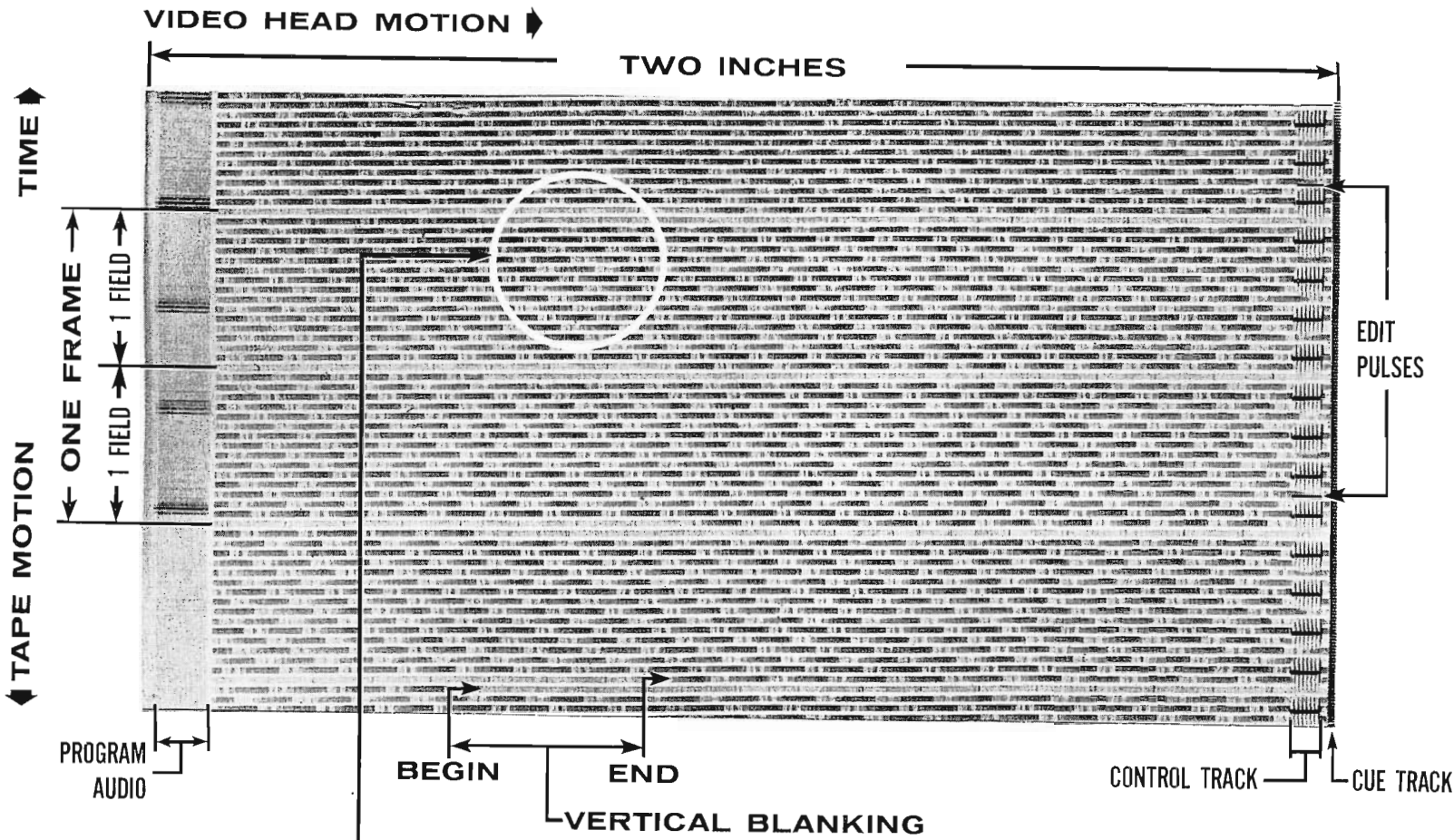

# HOW THE RCA

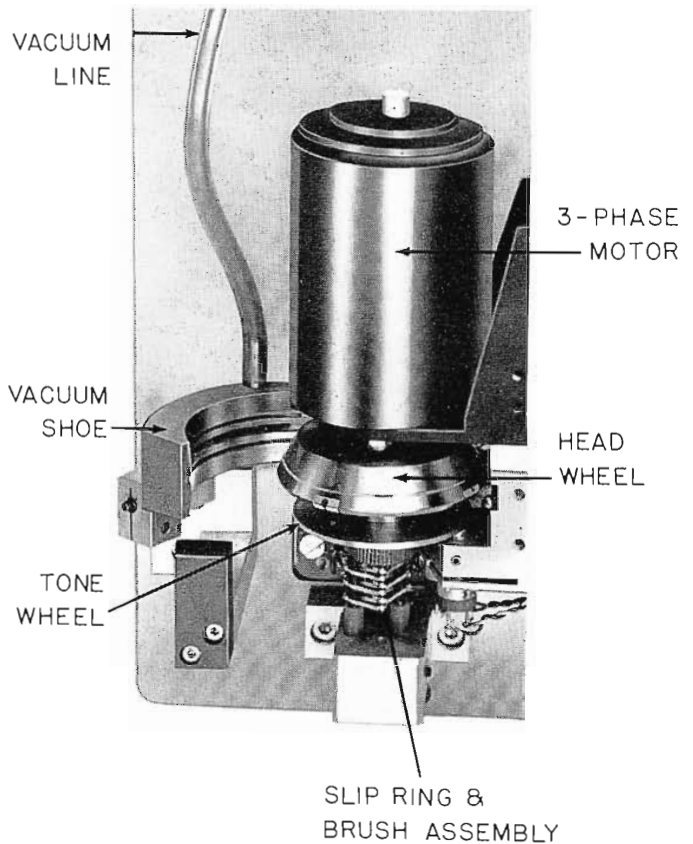

FIG. 1. Display of actual tracks as recorded by the RCA Color Video Tape Recorder.

FIG. 2. Close-up of a portion of the video head wheel panel assembly with vacuum shoe in the open position to expose details of construction.

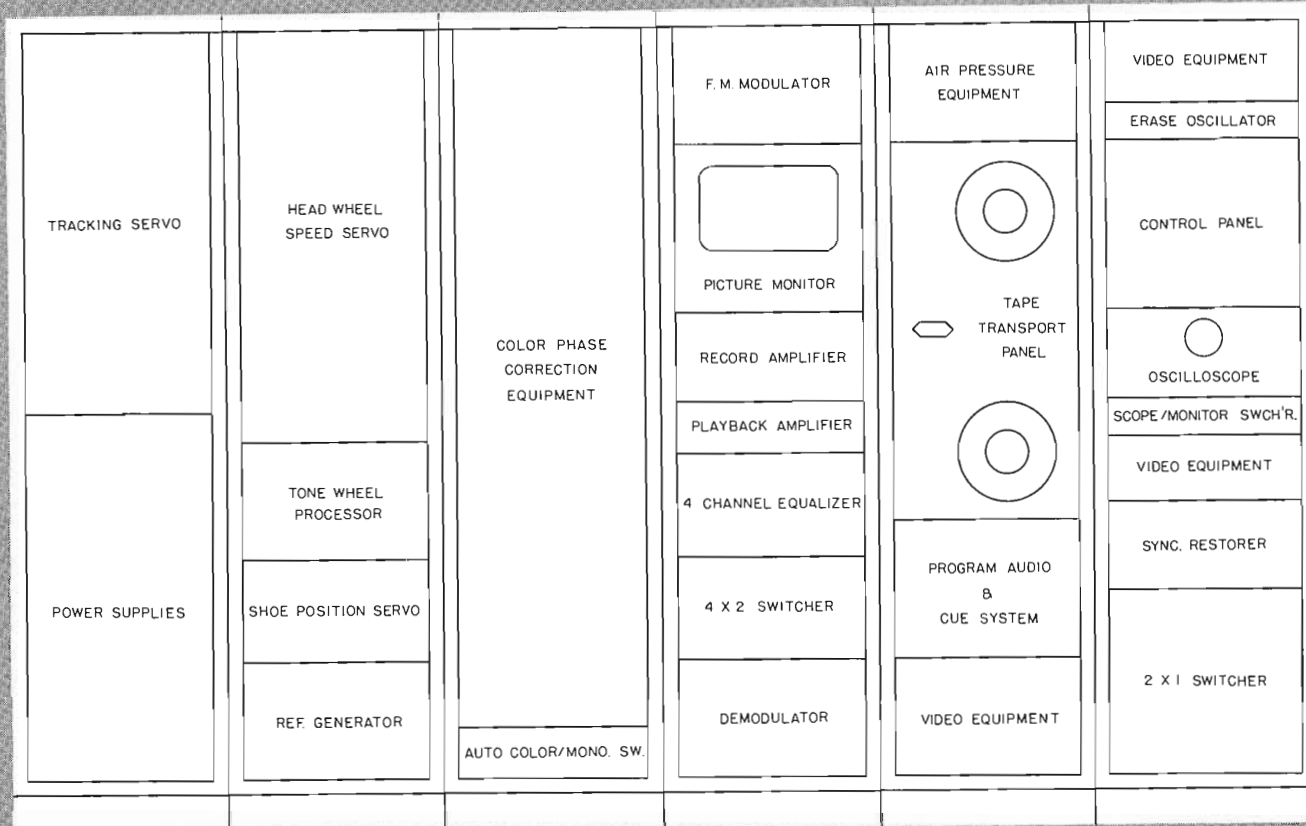

FIG. 6. Rack layout of RCA Color Video Tape Recorder. The three racks at the right form the operating position. The other three racks may be remotely located.

degrees apart. The error in this angle must be less than 30 seconds. The tape is curved along its width by means of a vacuum shoe which holds it in an arc, approximately 113 degrees long. Details of the head wheel panel assembly are shown in Figs. 2 and 3. The arc distance between program audio and control tracks is about 100 degrees. The plane of head wheel rotation is perpendicular to the motion of the tape. As the wheel rotates at 14,400 rpm (240 rps) and the tape is pulled through at 15 inches per second, transverse tracks are recorded with a pitch of 0.0156 inches (15.6 mils). The width of the head and hence the width of the track is 10 mils and there is a 5.6 mil blank space between tracks.

The length of one TV line along this track is about 5.5 degrees of arc or 0.1 inch. Therefore, about 18.4 TV lines are recorded on each transverse track. The actual number of TV lines used on playback is either 16 or 17 depending on their position on the track. The 18.4 TV lines are recorded in order to allow suitable overlap of information for reliable switch-

ing between heads during the horizontal blanking interval. The long term average number of TV lines used on playback is 16.40625. One TV frame (525 lines) comprises 32 transverse tracks or  $\frac{1}{2}$  inch along the direction of tape motion. The distance between vertical blanking periods is 16 tracks or  $\frac{1}{4}$  inch. In Fig. 1, the tape tracks were enlarged more than three times so that the details which have been discussed can be readily seen.

The magnetic video head is a tiny assembly held together by much larger clamping blocks. Figure 4 shows the video heads in place on the head wheel assembly; Figure 5 includes a highly magnified sketch of the head itself. The recording/playback gap is formed by a 100 micro-inch spacer held between the pole tips. The flat area formed by the top of both pole tips is 0.010 inch wide and 0.060 inch long. The two clamping blocks are made of a non-magnetic metal.

#### Equipment

The complete video tape recorder is contained in six standard cabinet racks (see

Fig. 6). The tape transport panel is conveniently located between a control panel and 5-inch oscilloscope on the right, and a 17-inch monitor on the left. The three racks shown associated with the tape transport must remain together. The other three racks in Fig. 6 contain the color phase correction equipment, servo amplifiers, and power supplies which can be remotely located. The master control panel in the rack can delegate operating control to a remote control panel for convenience in operation. The CRO-monitor switcher is a very handy device which allows the selection of a number of important signals for display on the scope. When one of these signals is selected by a pushbutton, the proper synchronizing signal is automatically fed to the scope. Similarly, other buttons allow the display of video input, monochrome output, and color output pictures on the monitor. These switching circuits are arranged so that no transients are allowed to feed out on the program line as the switch occurs.

The tape transport mechanism is shown in Figure 7. The 12 $\frac{1}{2}$ -inch diameter reels

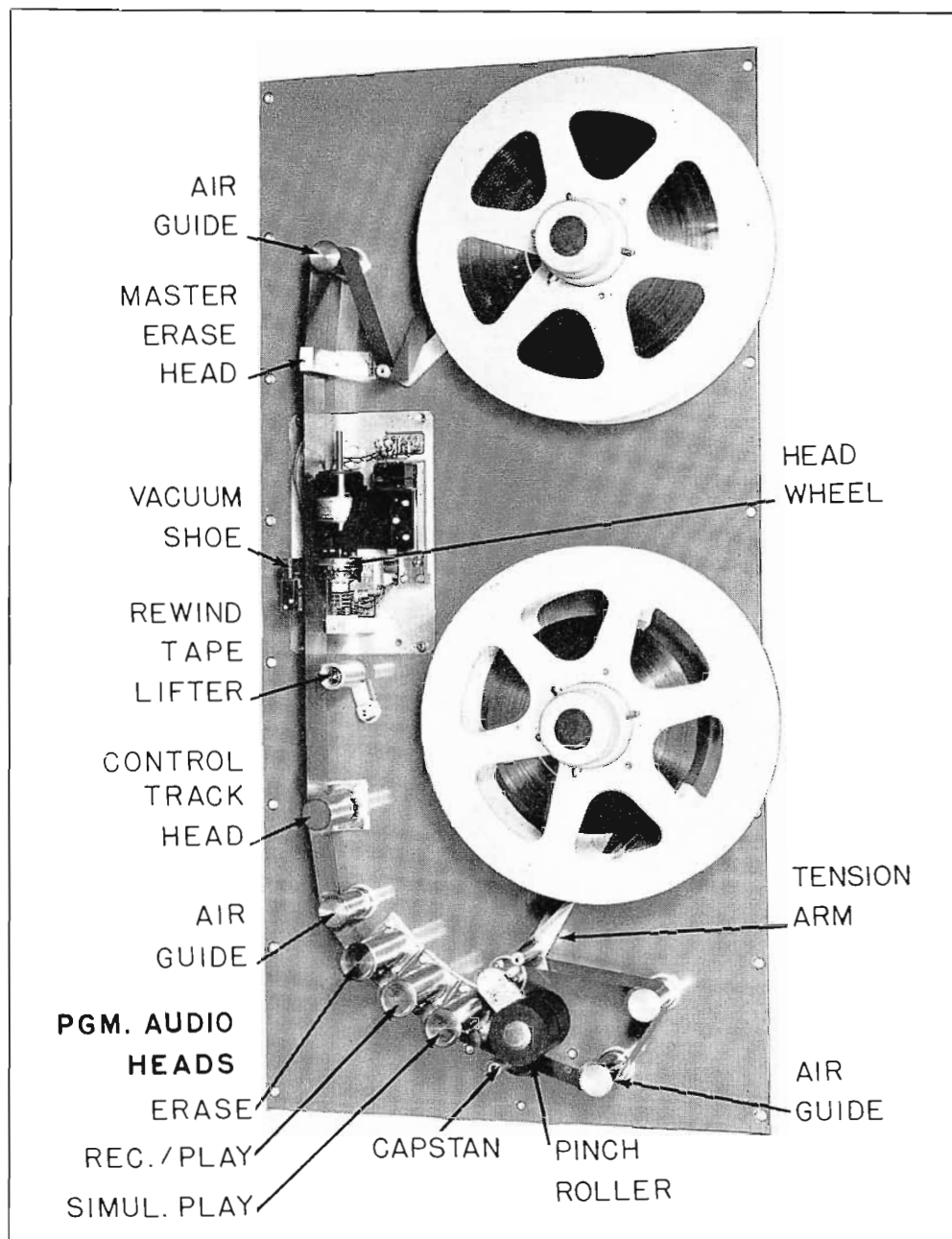

FIG. 7. Close-up of the tape transport mechanism. Call-offs identify key components for record and playback functions.

hold 4,800 feet of tape, providing 64 minutes of playing time. The main tape guide posts do not rotate; they employ the technique of air flotation. Air is forced through tiny holes in the post so that the tape rides over the post, touching it only at the very edge, where flanges are used to guide the tape. This results in very accurate positioning of the tape. Also the tape edge is protected from damage because only a minute amount of guiding pressure is required.

#### Recording Operation

The following discussion concerns the technical function of recording on tape: Figure 8, a simplified block diagram of the

complete color tape recorder, and Figure 9, an expansion of the video system block will be helpful in following the operation. The color phase corrector is not treated in detail here since it was described separately in a previous article.<sup>1</sup>

The tape is driven at the rate of 15 inches per second. During the record cycle the supply and take-up reels function mainly to provide proper tape tension. The tape is actually driven by the capstan assembly. (During rewind and fast forward modes the reel motors drive the tape.) The capstan motor is supplied with a constant

<sup>1</sup>"Color Processing in RCA Video Tape Recorder," BROADCAST NEWS, Vol. No. 99, February, 1958.

amplitude 60-cycle voltage and the tape is driven at a very constant rate of 15 ips. At the same time, the head-wheel servo controls the head-wheel motor speed and hence the head-wheel to 14,400 rpm or 240 rps. This is accomplished by comparing the frequency and phase of the 240-cycle tone-wheel pulse with a reference 240-cycle pulse. If there is an error in the tone-wheel signal, the servo amplifier adjusts the head-wheel motor speed to remove the error. The 240-cycle reference pulse is actually derived from incoming video as shown in Fig. 8. Also derived from this video signal is a 30-cycle editing pulse. (How the editing pulse is visually identified and used to facilitate tape splicing will be described later.)

At this point the capstan is pulling the tape at 15 ips and the head-wheel is rotating at 240 rps. The tape is held in an arc by the vacuum shoe and the magnetic heads in the wheel scan across the tape at the rate of 960 scans per second. The linear scanning speed of the heads is nearly 90 miles per hour.

Before the tape gets to the head wheel it first passes over the master erase head which cleans the entire 2-inch width. The clean tape then passes between the vacuum shoe and head-wheel where the video signal on its FM carrier is recorded. The motor shown connected to the vacuum shoe (Fig. 8) is not active during the record cycle, the shoe being locked in position. The tape next passes over the control track head where a 240-cycle saw-tooth signal is recorded. This signal will be used during playback to insure that the video heads

scan along their recorded tracks. The 30-cycle editing pulse, which is only about 100 micro-seconds wide, is merely added to the saw tooth. This does not interfere with the subsequent tracking operation, but is used later for tape splicing.

Next the program audio track is recorded: the area first having been erased by a separate erase head which is a little wider than the following record head. The simultaneous playback head, adjacent to the record head, allows the operator to monitor the signal being recorded.

On the opposite edge of the tape the cue channel record head provides a means for recording cue information. This can be in the form of voice cues or some other form of signal which could later be used for automatic control of the tape machine. A special feature of the cue channel is its operation in either record or playback mode

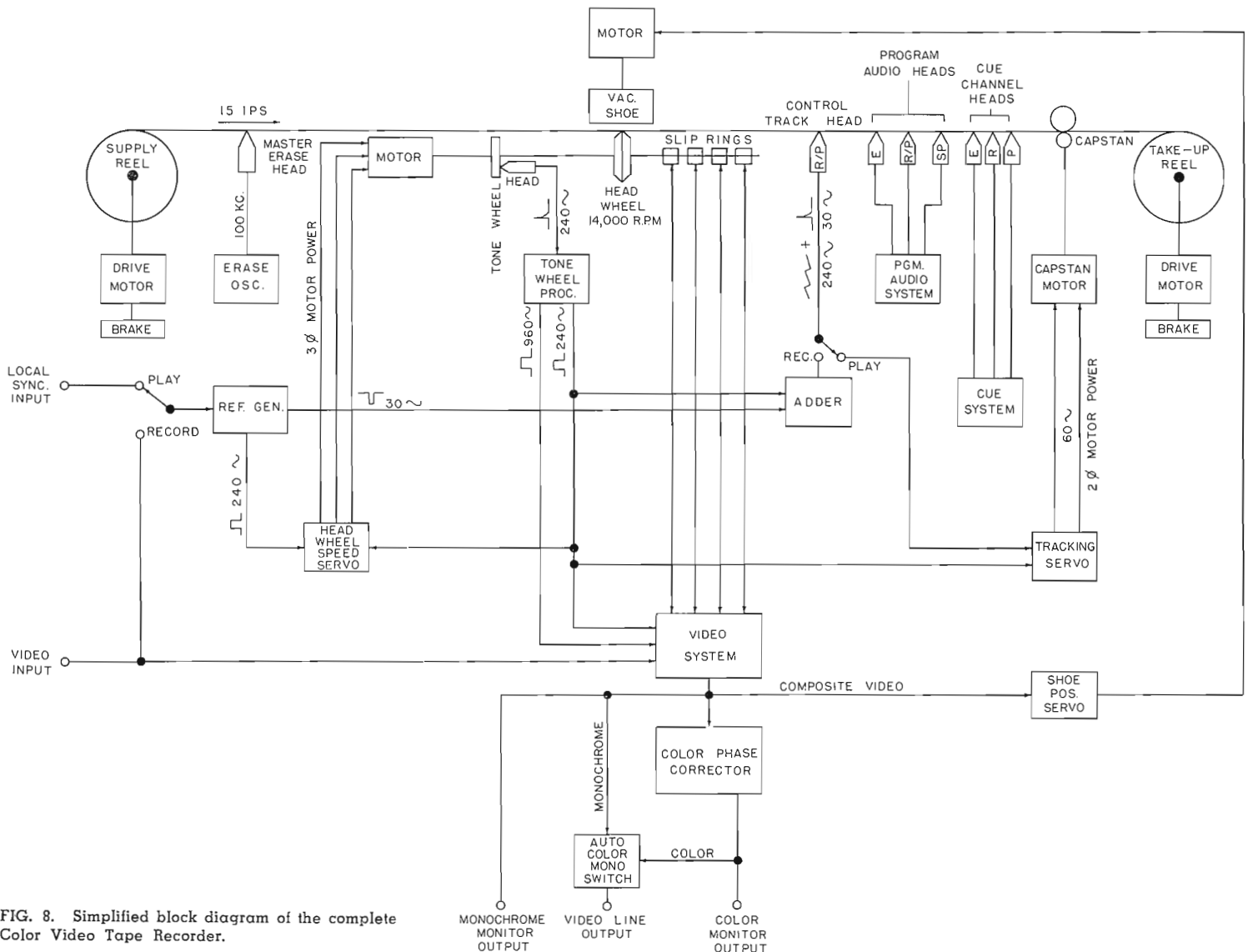

FIG. 8. Simplified block diagram of the complete Color Video Recorder.

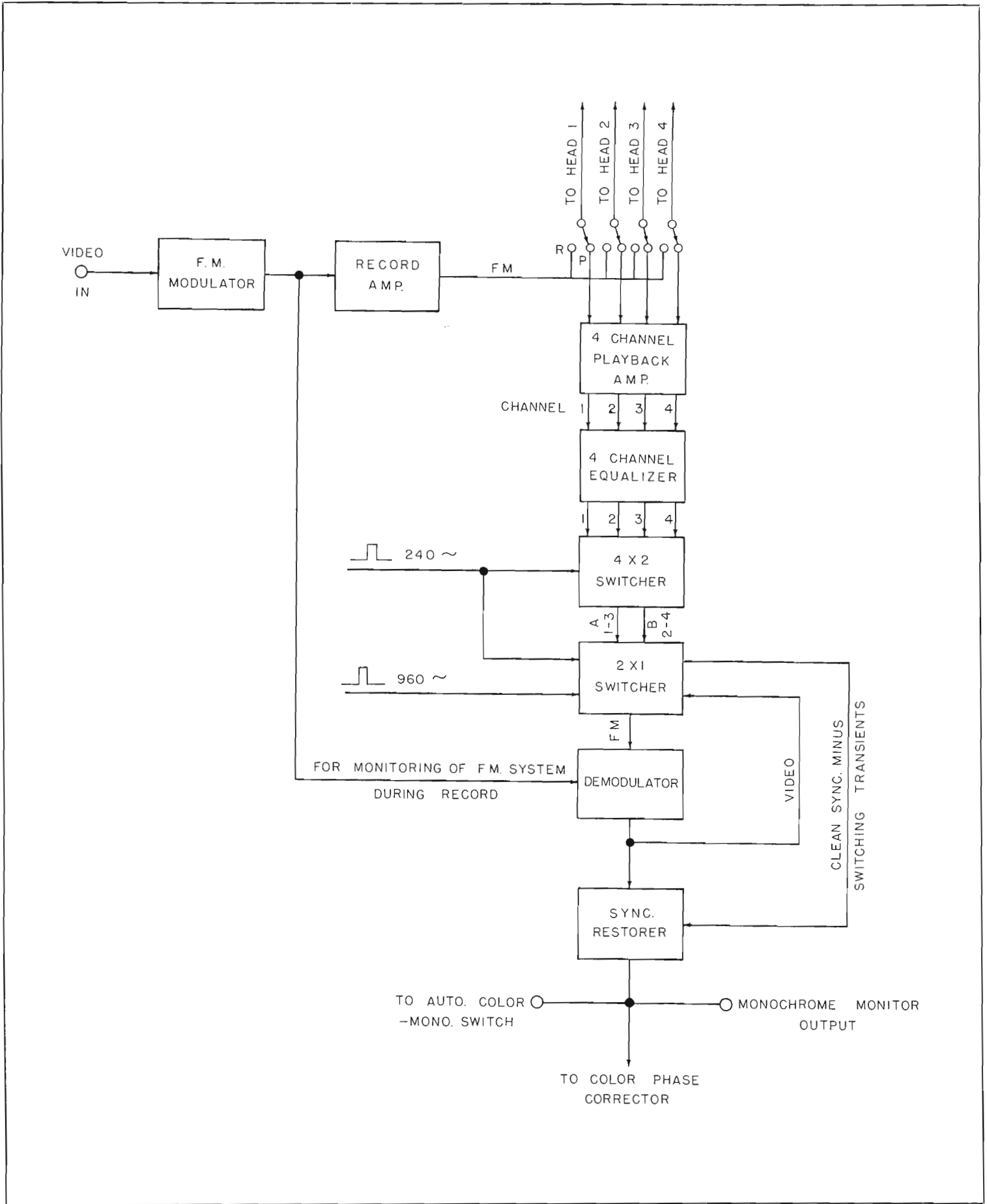

FIG. 9. Functional diagram showing the details of the video system block of Fig. 8.

regardless of the mode of operation of the tape machine. This allows the recording of cue information while playing back or previewing the video signal.

The composite video signal is on an FM carrier which is recorded on the tape (see Fig. 9). The incoming video signal goes directly to a frequency modulator whose carrier frequency is about 30 mc. The resulting FM signal is heterodyned with a 35.5 mc local oscillator, resulting in a final FM signal having a carrier frequency of about 5.5 mc with a deviation from about 5 to 6 mc. (For the sake of simplicity, assume a carrier frequency of 5.5 mc. Actually, there is no "center frequency" since the modulator is clamped; that is, the tip of sync always corresponds to an instantaneous carrier frequency of about 5 mc regardless of the duty cycle of the video signal. Similarly, peak white corresponds to a frequency of about 6 mc.) It is the FM signal which is recorded on the tape. The magnetic head and tape response is such that the actual playback pass band is roughly 1 to 7 mc. This results in a vestigial sideband FM signal—the lower sideband plus only a part of the upper sideband is passed.

The FM signal goes to a record amplifier which essentially drives all four video heads in parallel through a slip ring/brush assembly. Therefore there is no need of head channel switching during the record cycle. It is the playback operation which is more involved. This is fortunate from the standpoint of equipment complexity and system reliability. If a tube or component failure occurs in the video system, there is a good chance that the signal would be properly recorded on the tape and the failure would merely have to be corrected before playback.

### Playback Operation

The head-wheel in the playback mode again rotates at 240 rps by virtue of the same servo control as used in recording. The only difference is that the timing reference is now local sync. The 240-cycle tone wheel pulse is the main timing signal for the rest of the machine. The most important servo function during playback is the tracking servo (see Fig. 8). Its job is to see that the control track signal passes over the control track head in exactly the right phase, so that the video heads are reading right on top of the transverse video tracks. To accomplish this the 240-cycle tone wheel signal phase is compared with the phase of the control track saw tooth. The speed of the capstan motor is controlled by the servo amplifier to establish the proper phase relationship.

The FM signals which are being picked up by the four heads in the wheel are fed through the slip ring/brush assembly to the video system (see Fig. 9). These signals are fed to a 4-channel amplifier and in turn to a 4-channel equalizer. The equalizer essentially adjusts the frequency response in each channel so that the 4 channels are identical.

Next the signals go to the 4 by 2 switcher. The 240-cycle, tone-wheel signal operates this electronic switcher so that head signals No. 1 and No. 3 feed out channel A, while No. 2 and No. 4 feed out channel B. Because of the 90-degree spacing of the heads, No. 1 and No. 3 are never reading signals at the same time and therefore can share channel A. The same is true for No. 2 and No. 4 on Channel B. There is about a two TV line overlap in the transverse track signals which means that immediately before head No. 1 leaves the tape, head No. 2 has entered and is reading the same information as head No. 1 (except it is near the opposite edge of the tape). Similarly, there is overlap between heads No. 2 and No. 3; No. 3 and No. 4; No. 4 and No. 1. It is the function of the 2 by 1 switcher to select the final signal during these overlap periods. This is accomplished by the 960-cycle gate which identifies the overlap interval in combination with horizontal sync pulses derived from the video signal itself. The demodulator feeds the video signal back to the switcher for this final switching operation.

The actual switch is made during the horizontal sync period which occurs during the horizontal blanking interval. The composite video signal out of the demodulator goes to a sync restorer which clamps the signal, removes the switching transients, and provides three parallel outputs. One of these outputs goes to the color phase corrector and another goes to the automatic switch which instantaneously selects the proper line depending upon whether the signal coming off tape is color or monochrome (see Fig. 8). This switching chassis then provides a 75 ohm sending-end terminated program line feed.

### Splicing

Special provisions for tape splicing have been included in the video tape recorder. As mentioned earlier, the reference generator of Fig. 8 has a 240-cycle pulse output which is derived from the incoming video signal. This pulse, in conjunction with the head-wheel servo, causes vertical sync to be recorded in the same position

on the transverse tracks on all machines. The 30-cycle editing pulse is derived from the incoming video signal, and is recorded at half-inch intervals on the control track between the sharp edges of the control track saw tooth (see Fig. 1). The edit pulse is positioned near the track which contains alternate vertical sync intervals. The position of this pulse is fixed relative to vertical sync and will be the same in all RCA Video Tape Recorders.

When a splice is to be made, the tape is pulled out of the head wheel/shoe assembly and the edge of the tape sprayed with a carbonyl iron suspension. An inch or so of sprayed area is all that is needed to easily identify the editing pulses which are clearly visible every  $\frac{1}{2}$  inch along the control track. The edit pulse is used to position the tape in a simple cutter so that the tape is cut right through the vertical blanking interval. When the spliced pieces (joined by adhesive splicing tape) later pass through the head wheel assembly on playback, the sync will appear essentially as a continuous signal and will prevent vertical rolls from occurring in TV monitors and receivers.

The shoe position servo shown in Figure 8 helps provide a continuously usable signal as a splice passes through. The two pieces of tape which were spliced may have been recorded at slightly different head wheel-to-tape pressures (remember that the head wheel is actually pushed into the tape a few thousandths of an inch). If the transverse tape stretch (due to head wheel-to-tape pressure) is slightly off, tiny jogs will appear in vertical lines in the picture. These jogs can be removed by correcting the transverse tape stretch through adjusting the head wheel-to-tape pressure. This is what the shoe position servo does by slightly moving the position of the vacuum shoe, depending upon the presence of an error signal which is derived from the playback video signal.

### Convenient Operation

Design of the RCA Color Video Tape Recorder has incorporated numerous techniques which result in straightforward operation. All components have been rack mounted for ease of installation, operation and maintenance. Both color and monochrome operation are accommodated. By eliminating the rack of color processing equipment it is adapted for monochrome operation only. Thus, this RCA Video Tape Recorder fills every requirement for television broadcast and closed-circuit applications.

# PROGRESSIVE STEPS TOWARD AUTOMATION IN TELEVISION PROGRAMMING

*The Basic Building Blocks Consist of Products Designed for Automation,  
and Equipment for Controlling the Station-Break Period*

by A. H. LIND, Manager, Audio and Mechanical Devices Engineering

The advantages of the use of automation techniques in radio and television stations are threefold: First, automation can make possible increased income for the broadcaster since the improved performance makes a station's programs more appealing to viewers and sponsors alike. Second, automation can eliminate operating errors by reducing the confusion attendant to the station break or commercial insert (during which time most switching errors occur). Third, automation can permit more efficient usage of skilled personnel, thereby it may be possible to hold high caliber people, who are presently being attracted to more lucrative jobs. Because of these advantages, many radio and television stations are planning now for automated operation. In considering use of automatic devices, many of which are available now, it is well to note that the broadcast plant can be automated to a high degree in a series of planned progressive steps, each of which will produce immediate benefits.

## Programming Task for Automation

In a broadcast plant there are three types of TV signals to be handled. First, there are signals derived from recorded programs: These include motion-picture film, slide transparencies, positive prints or opaques, magnetic tape and disk recordings. Second, there are direct live-pickup pictures. Third, from the standpoint of signal handling, there is the master control or program assembly function where the signal arrives in "packaged" form via cables from either local or remote sources. In the first two cases there are control functions which must be performed in the process of generating the signals, both picture and the accompanying sound. In the third case it is a matter of switching the correct signals at the correct time.

Generally, TV programs can be classified into the following kinds:

1. *Short precisely timed sequences.* In the vast majority of cases these short sequences are station break or commercial inserts. Also used are short film inserts in live programming such as news scenes, slide titles and program announcements. Station-break programs are the most rigidly scheduled with respect to clock time. Other types might be scheduled to occupy a precise time block, but not so rigidly scheduled with respect to clock time.
2. *Feature film.* Motion-picture films frequently provide programs of several minutes to several hours duration.
3. *Direct pickup live programming.* This is a broad area of programming ranging from carefully planned and rehearsed studio pickups, through indoor and outdoor athletic events and a multitude of other unrehearsed on-the-spot pickups.

A program day is usually made up of a variegated mixture of these different kinds of programs. The program material, live or recorded, is transduced in appropriate TV machines into television picture and sound signals which are next subjected to program switching for signal selection to establish the program output (see Fig. 2). It is important to note that in addition to signal selection switching, machine control switching is often required. This includes such functions as starting and stopping motion-picture projectors, changing slides, switching optical paths by means of an optical multiplexer, starting and stopping tape and disc recordings. The pattern indicated here, in greatly simplified form, is representative of the basic television studio system as it is generally used today.

## Three Steps to Automation

It is logical to propose that automatic equipment be used to move forward in this era of automation. But where should one start? Fundamentally each machine should be as automatic or self-controlled as possible. This minimizes the amount of external control required. Once the machines are available in a broadcast plant, they are of immediate use and benefit, in that manual operation can be streamlined and simplified.

A second step is the introduction of automatic "station break control" to handle programming of the so-called "panic period" in which several events of short duration take place in rapid-fire sequence. The third logical step is adding an automatic "system control" to handle extended periods of operation. With the first two steps as background, the automatic system control can be accomplished without becoming overwhelmingly complex. It can provide a system capable of unattended operation for either brief or extended periods.

### Step 1: Automatic Machines

In the area of automatic machines, programming from recorded material lends itself most readily to automation.

### Automatic Cuing of Projectors

The cuing or positioning of motion-picture film in a projector to assure that picture and sound will start at the instant the program schedule indicates, is a problem which involves careful operating practice. Since the projector requires a finite period of time to accelerate to stabilized running speed, the frame placed in the gate of the projector must be ahead of the first frame to be used. The amount of leader depends upon the start-to-stabilization time



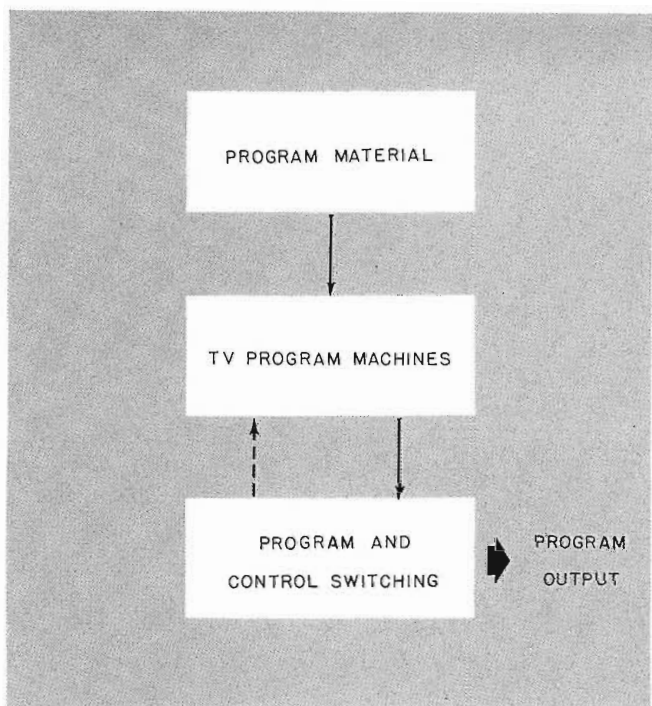
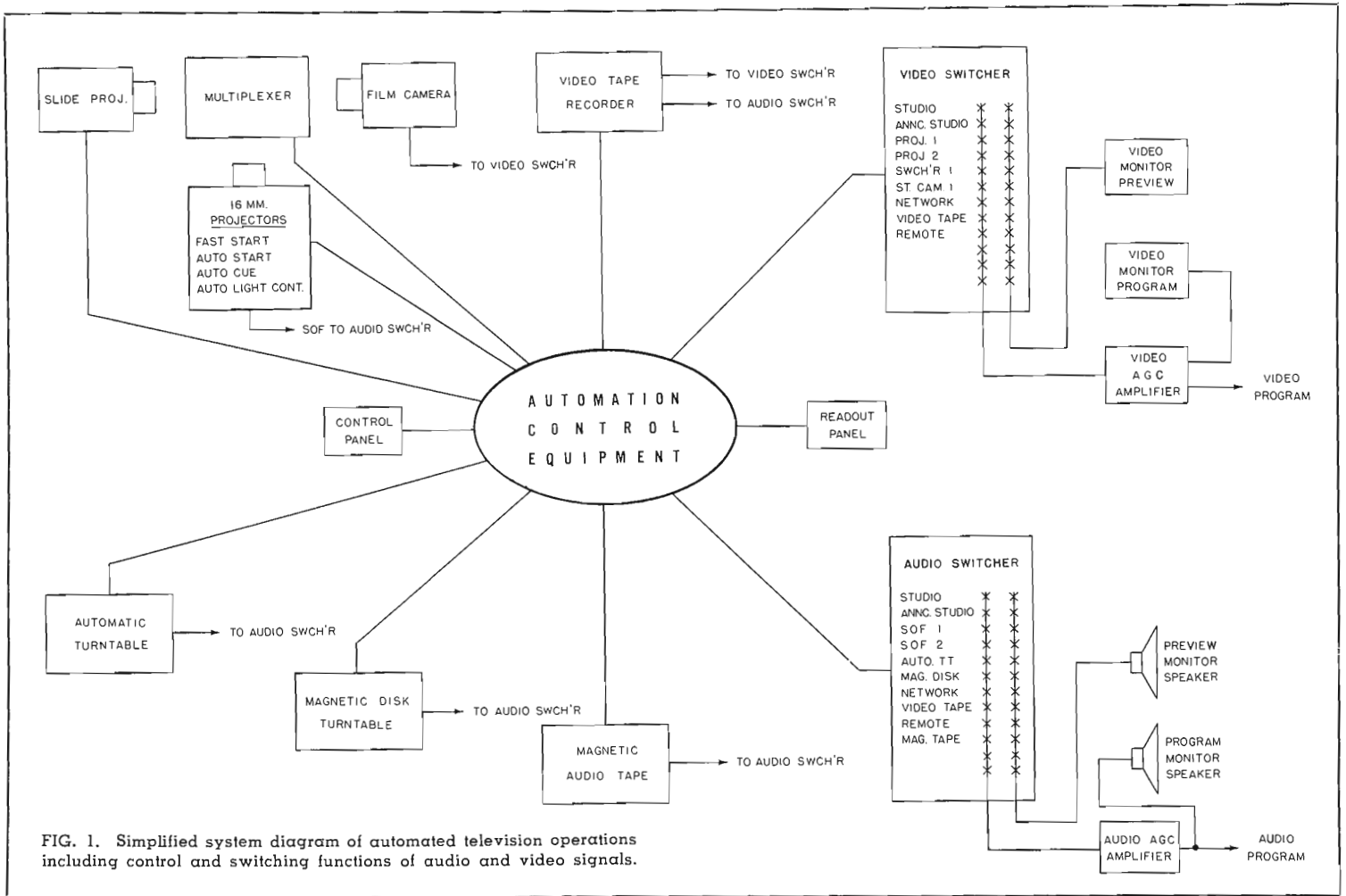

required for a given projector. In present practice this is a manual operation. It requires that an operator be at the projector in use prior to every film sequence to be run. However, an automatic cuing facility can be added to the film projector to perform the cuing function. This mechanism detects the presence of a suitable cue mark on the film leader and in turn actuates controlled stopping mechanisms to bring the film to a stop with the specified frame in the gate. It now becomes possible to run through a series of film sequences spliced together on a reel, with projector start being the only operation required. This, of course, can be performed remotely. Following the completion of a given sequence, the program line is switched to another picture source, but the projector continues to run until the cue mark for the following sequence is detected and the machine is brought to a controlled stop with that sequence cued for starting. Automatic cuing for RCA Type TP-6 and TP-35 Series Projectors has been designed and will be available in attachment form in the near future.

#### **Fast Starting of Projectors**

In addition to cuing the film for proper start, the start-up time of the machine must be accommodated by activating the machine several seconds prior to switching its output to the program line. Three interdependent functions must be accomplished before satisfactory picture and sound can be obtained. The film and rotating parts of the machine must be accelerated to the 24 frames-per-second synchronized speed to establish proper intermittent motion of film at the gate. The light shutter must be rotating at the proper speed and locked in the proper phase with respect to the film intermittent. Finally the film must reach stabilized, uniform motion at the sound take-off point, which is separated by 26 frames from the film gate (where the film motion is intermittent). A modification that provides for very fast starting of RCA TP-6 projectors will shortly be available. With this modification, start-up time is reduced to less than one second and the TP-6 prepared for automatic operation.

#### **Automatic Turntables**

The Type BQ-103 Automatic Turntable is presently available to provide means for

storing one hundred 45-rpm records and, when actuated, selecting records in sequence or in random order. The record is removed from the storage rack and placed on the turntable. The pickup arm is next positioned so that the stylus is in the lead-in groove of the record. The turntable platter is then de-energized and quickly braked to a stop. The machine remains in this ready condition until a start-switch circuit is closed. Upon completion of playing a record the machine returns it to the proper place in the storage rack and goes on to ready the next record for playing.

#### **Automatic Slide Projectors**

Slide transparency projectors, such as the TP-7A, are now available with a substantial slide capacity (which is a requirement for an automatic system). The TP-7A is a rugged, reliable projector designed for remote control service. The machine is basically sequential in operation. It is capable of showing a rapid succession of slides with very fast slide-to-slide transitions. If sequential operation through a series of slides will fit the programming desired the TP-7A will lend itself to automation immediately.

A machine which will permit the selection of slides in random order makes for more flexible and efficient programming because slides can be used repeatedly without rearranging the loading of the drums. Such random selection facility is soon to be available in the TP-8 slide projector. This unit is designed basically for pushbutton-manual, remote-control operation, but it will be possible to readily integrate it into automatic control systems.

#### **Automatic Gain Control**

The need to keep the transmitted signal levels within proper bounds is, of course, always present. Automatic gain control amplifiers such as the BA-6A and BA-25A for audio and the TA-21A for video are also available. They are beneficial in relieving operators of much of the gain riding that otherwise may be necessary. Such amplifiers are essential to satisfactory unattended operation.

#### **Automatic Light Control**

Optimum operation for vidicons in film cameras is obtained when the highlight

brightness of the optical image on the photo surface of the tube is such that the target voltage is optimized and the beam just discharges the highlight. Excessive beam current will produce deterioration of resolution. If the sensitivity is varied to accommodate variations in the film image brightness by changing the target voltage, spurious effects can appear due to deviations from field flatness, distortion of the transfer characteristic, and shifts in black level behavior. The present method of maintaining constant highlight brightness at the vidicon by manually controlling the position of a neutral density filter disk in the projector light path works very satisfactorily. Development work is currently in progress to make the neutral density light control automatic. A servo loop including the vidicon camera chain, a level measuring and error detecting amplifier plus power amplifier and servo motor to drive the neutral density filter disk can reduce the need for manual operation.

A word of caution is in order about both automatic gain control and automatic light control devices. It is not practical, at least at present, to build into such servo equipments the kind of subjective judgment that can be exercised by a human operator. Thus, some extremes in pictures and sound may not be aided (in some instances may even be deteriorated), because the automatic device uses a very objective judgment with limited IQ instead of an aesthetic subjective judgment.

Once automatic machines are available, fewer control switching functions are required. Thus, the addition of future automatic control is made more practical and straightforward.

#### **Step 2: Automatic Station Break Control**

The station-break period of programming is normally a very hectic time which is frequently referred to as a "panic period." Station breaks and commercial spots are of short duration thus they follow one another in rapid succession. An approach using a preset control of adequate capacity which will automatically control programming for a period of several minutes constitutes the second step in automation.

The automatic station break control system is illustrated in Fig. 5. The coded

control memory in this case consists of preset groups of relays. Each group of relays stores information to control one "event" which expresses all switching functions that are required for a program output change. The programming operation may be as simple as selecting the sequence in which the automatic machines are started. The actual switching may be manually carried out. Or, in a more comprehensive system the switching can be automatically accomplished on a preset, time-duration per event basis.

In order to handle last-minute changes in program content that cannot be preprogrammed due to lack of time, and provide emergency means of control, a manual control panel which can supercede the automatic control is provided.

### Step 3: Automatic System Control

The third step is an extension and expansion of the second. Functionally the diagram of Fig. 5 still applies. In general the system is expanded in capacity of stored information and manner of time control. If perforated paper tape is used for the coded control memory, automatic control for periods of 24 hours or more is quite possible.

While it is possible and practical to utilize many standard product components as building blocks in an automatic control system, a given broadcast station's requirements must be studied on an individual basis and a system plan tailored accordingly.

### Step-by-Step Approach Logical and Economical

To build toward automatic programming by obtaining individual basic equipments that are automatic, or in some instances modifying existing equipments to make them automatic, is the first step. Next, the station operator can take further advantage of the automatic machines by automatically controlling them to ease the human operating problem during station-break periods. Finally, based on the foundation of the first two steps, the automatic system control can be expanded if desired and the goal of automatic programming achieved through system evolution.

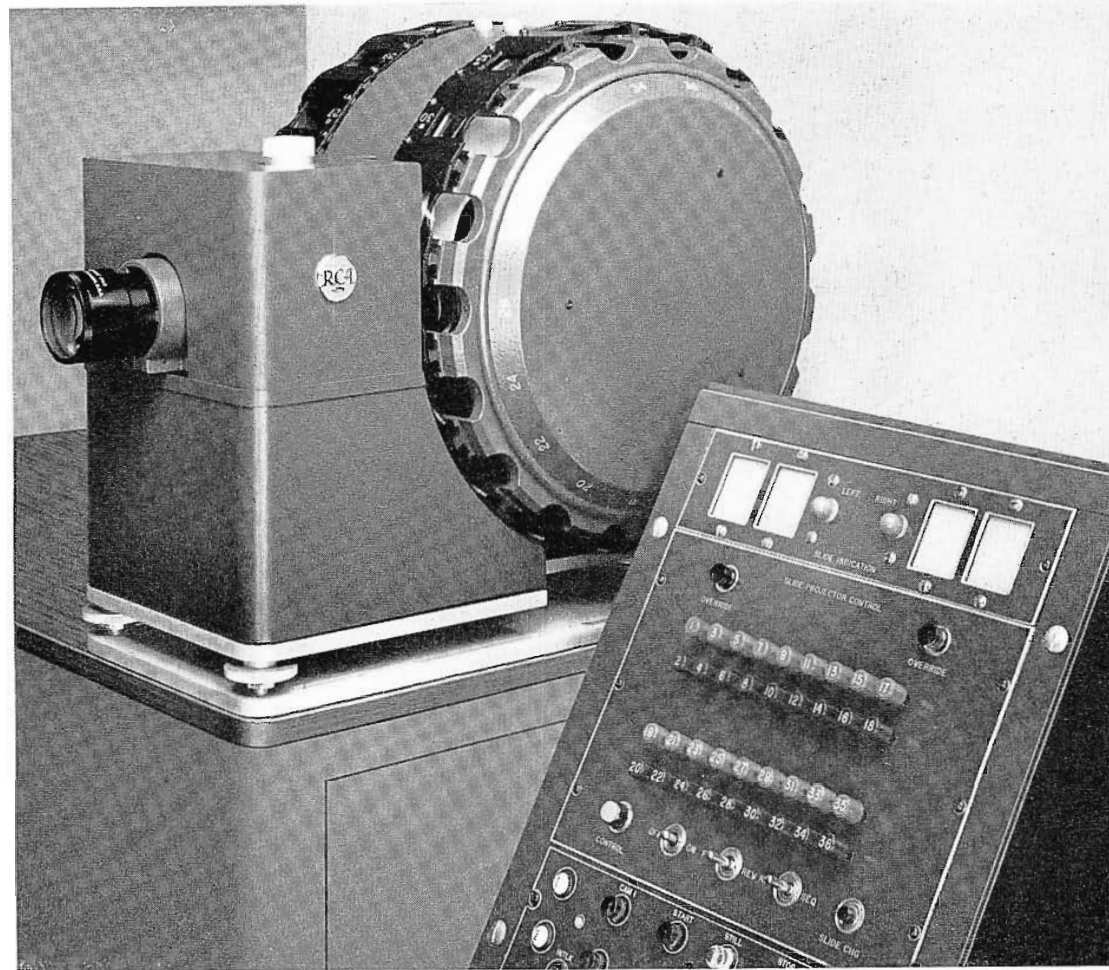

FIG. 4. Random Selection Slide Projector, Type TP-8, may be readily integrated into automatic control systems.

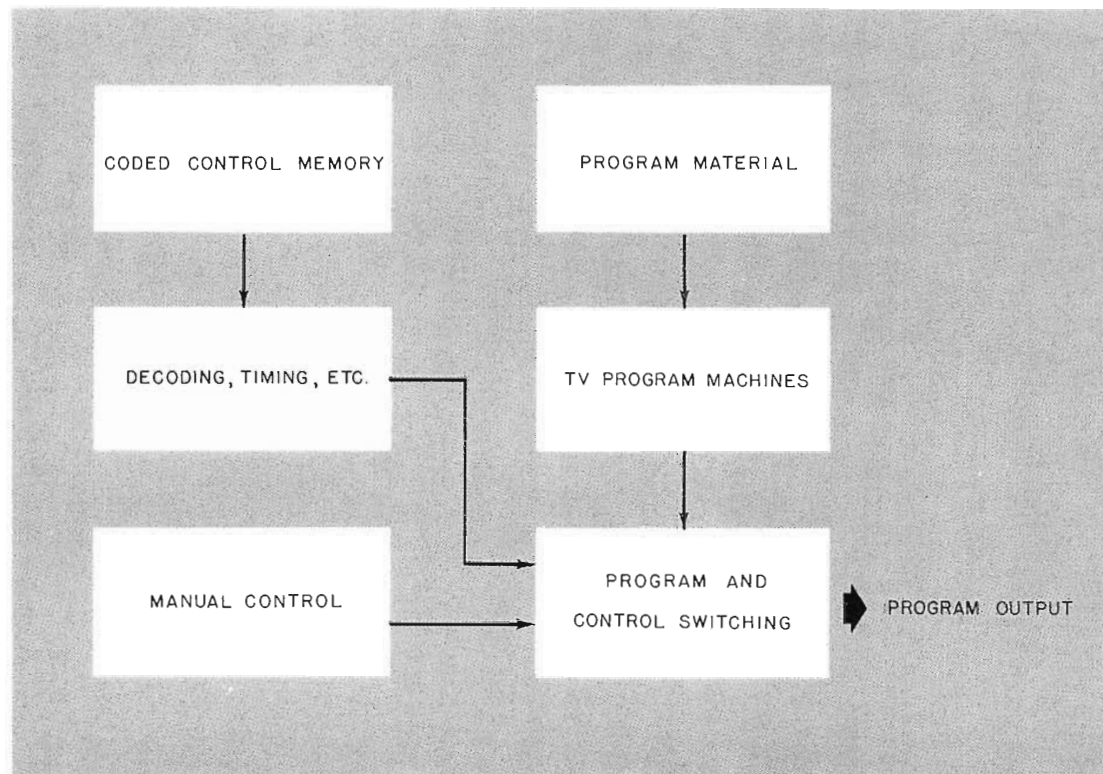

FIG. 5. Functional diagram of automatic control system showing relationship of memory and timing devices to basic program equipment.



# WTPA-TV, FROM 12 TO 25-KW

*Advance Planning Permits Conversion*

*by PAUL D. GROSS, Chief Engineer, WTPA-TV*

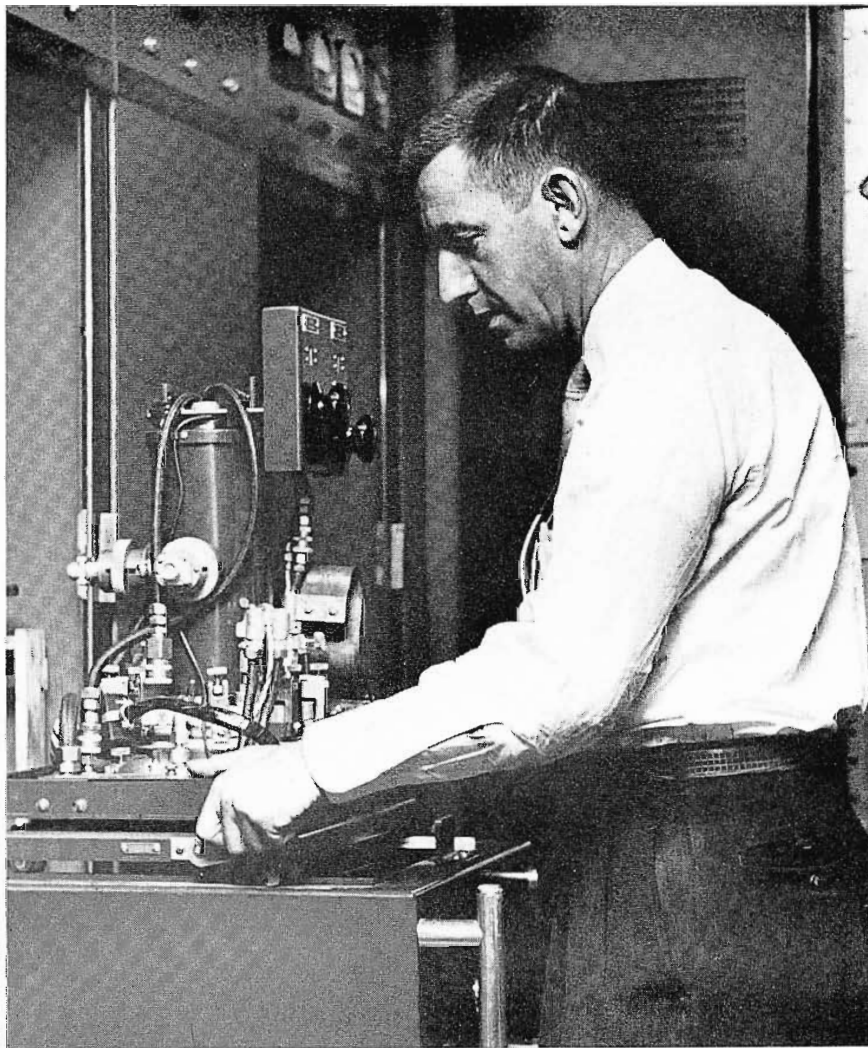

FIG. 1. Chief Engineer, Paul D. Gross, installs the 6806 UHF Tetrode in the visual PA of WTPA's 25-kilowatt transmitter.

Transmitter conversion from one to twelve and then to twenty-five kilowatts, adding RCA amplifiers all the way, has been accomplished at WTPA in a block-building plan which required no modification in building layout. Man hours were kept to a minimum, much of the original installation was re-used, and savings amounted to thousands of dollars.

From the first, our plan has been to attain high power as equipment to do so became available. With the installation of an RCA Ultragain Antenna, Type TFU-46AL, early this year, the station has begun operation at one megawatt ERP on Channel 27.

### Station Operation Began 1953

Station WTPA transmitted its first television signal on June 19, 1953, and regular programming was initiated July 6. At that time, WTPA was operating with a 1-KW Transmitter, Type TTU-1B. Installation of the transmitter by the station engineering staff had begun as soon as the transmitter building was under roof, but was still far from completion. In fact, the finishing touches were not put on the transmitter plant until after programming had begun.

WTPA operated with the TTU-1B transmitter for a period of 16 months. On October 19, 1954, sixteen months to the day, the station put into operation a 12-KW Transmitter, Type TTU-12A. This combination of original 1-KW transmitter with 12-KW amplifier was in service for about the next three years.

### Conversion to 25-KW in 24 Days

Consistent with original plans for highest power, WTPA applied for and was

# HARRISBURG, PA., MAKES CONVERSION TRANSMITTER FOR MEGAWATT OPERATION

*Without Building Changes; Enables Station to Remain On-Air While Equipment is Being Modified*

granted a Construction Permit to increase ERP to one megawatt. Immediate delivery of transmitter and antenna equipment was accepted from RCA, and on July 22, 1957, conversion of the 12-KW transmitter to 25 kilowatts was begun. After 24 days (and nights) of constant work, WTPA engineers put into operation the first TTU-25B transmitter converted from the station's existing TT-12A.

Both mechanical and electrical modifications were completed according to a cabinet-by-cabinet plan, which would allow the transmitter to operate at a full 12-KW

output during most of the modifications. Each cabinet was modified, first mechanically then electrically, starting with the thyatron and rectifier cabinets. By completing this work in one operation the 12-KW transmitter output was maintained.

Next the plan called for modification of the main control cabinet, which involved the mounting and changing of several switches and relays. At the same time the main control cabinet was separated from the visual PA and the auxiliary control cabinet from the aural PA. Power was cut back to one kilowatt, and a new wiring

FIG. 2. Modifications were made cabinet by cabinet and the output of the 12-kilowatt transmitter was maintained. Checking blueprint are Assistant Chief Engineer Charles Baker (left), and Operating Engineer, Raymond Julian.

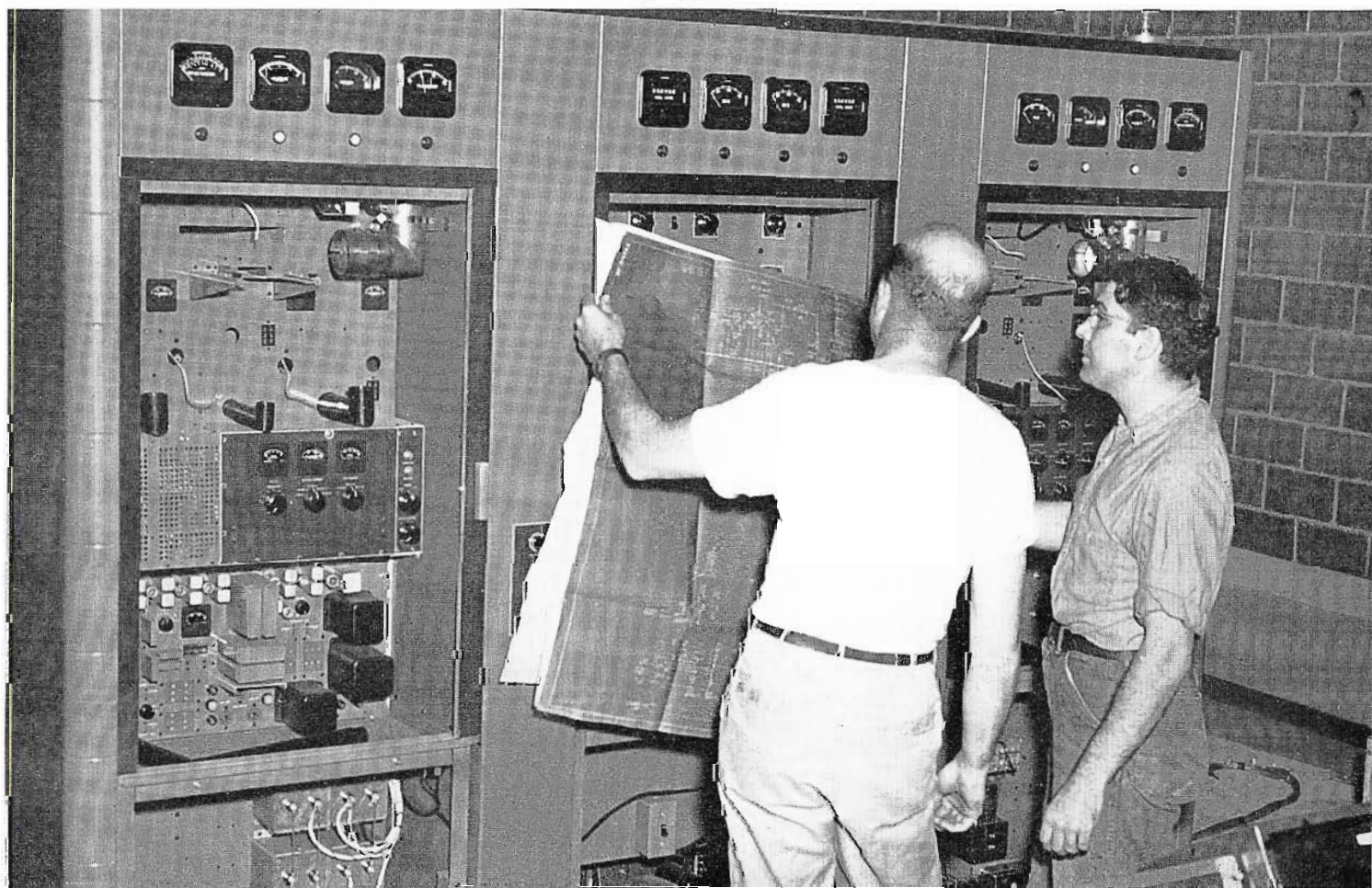

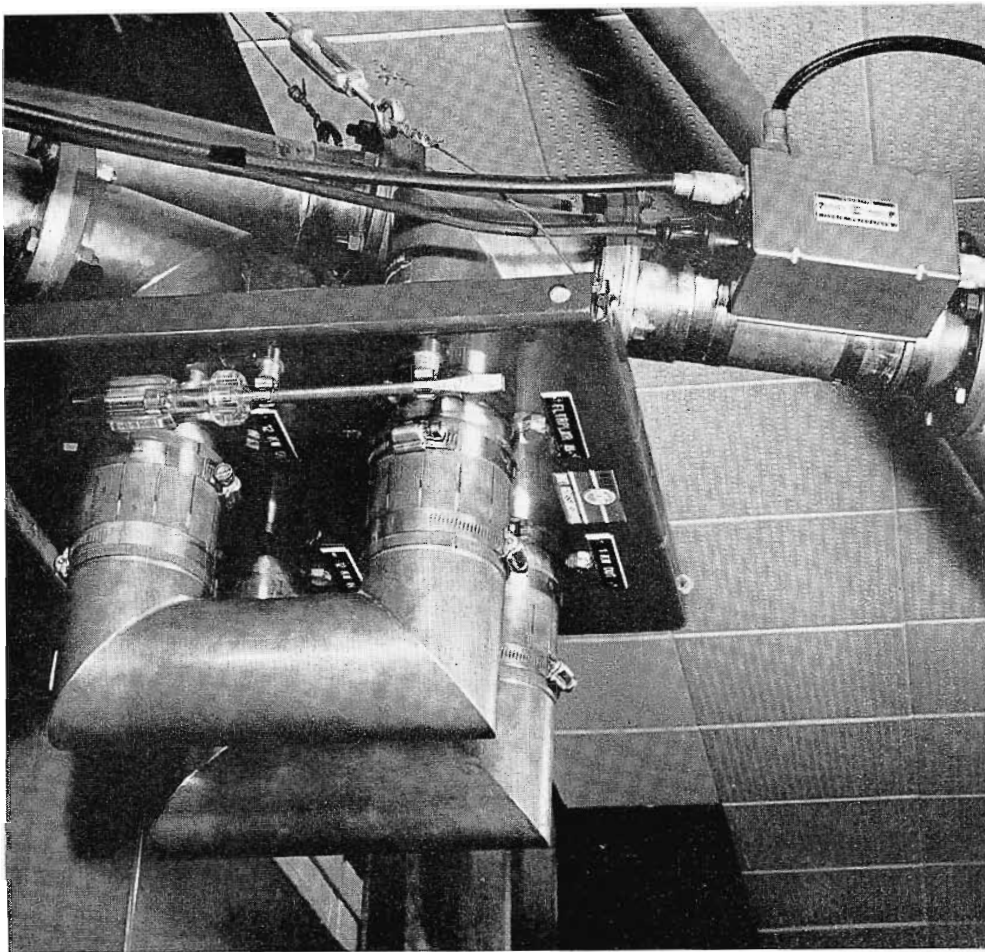
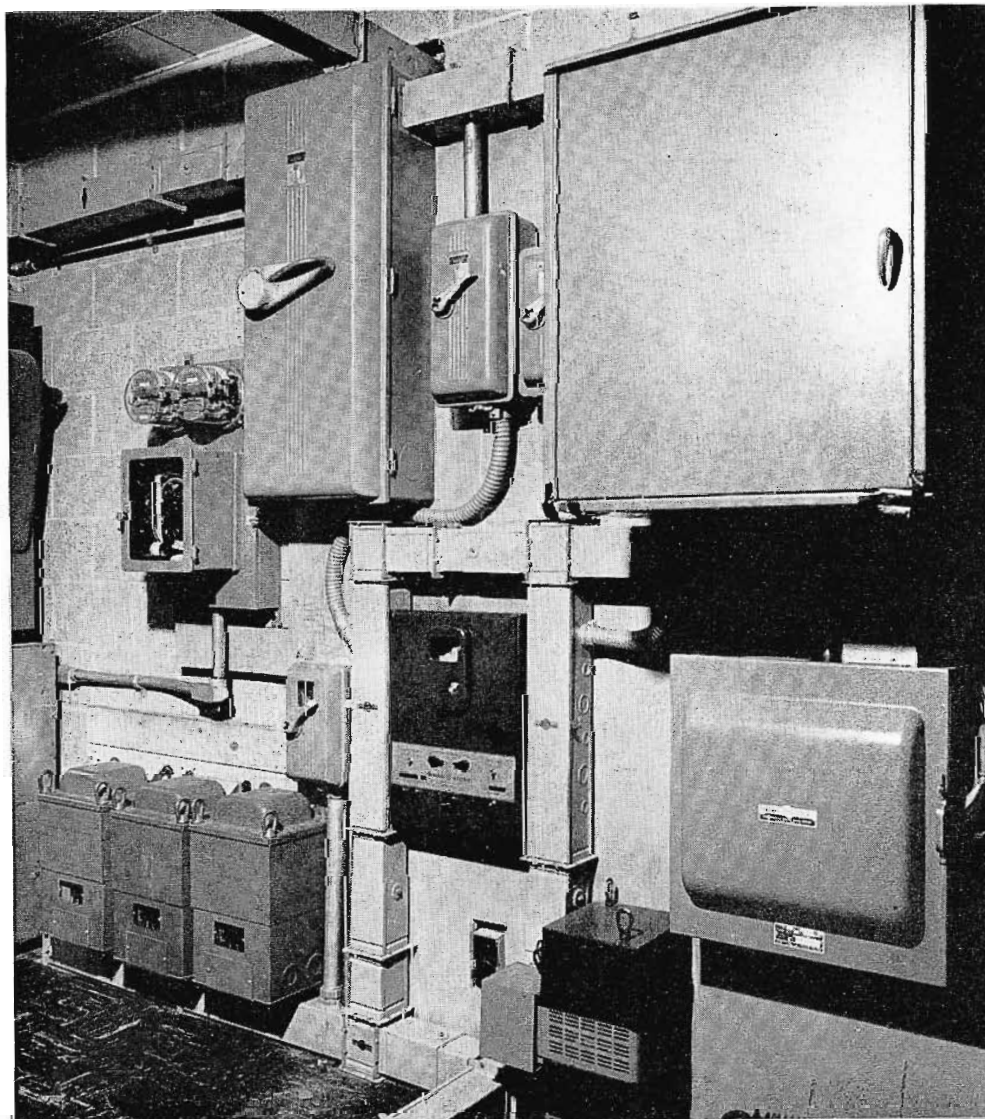

FIG. 3. Manual coaxial switching panel permitted rapid manual switching between 1 and 12 kilowatt outputs during conversion, and ultimately between 1 and 25 kilowatt outputs after conversion was completed.



harness was installed so that the transmitter could be returned to 12-kilowatt operation. The cabinets were separated a fixed distance to permit mounting the water columns at the proper intervals in the water compartment.

By August 1, mechanical and electrical modifications to the aural and visual PA's were begun. The aural PA was taken out of operation and the aural transmitter operated at one kilowatt output. This was facilitated by the coaxial switching panel shown in Fig. 3. The arrangement permits rapid manual switching between one and twelve kilowatt outputs.

On August 7, the aural and visual PA's of the 12-KW transmitter were taken out of service, and WTPA went on the air with the original 1-KW driver for a period of seven days. Immediately, the plumbers and electricians went to work. The old plumbing was removed as was the old wiring, and new plumbing and electrical wiring installed. By August 12, this work had been completed, with new transformers and high-voltage cables being installed. On this date the power company changed the primary service from 230 to 480-volt service. This was accomplished in record time: Service was cut at 6 A.M., the existing pole transformers were removed and new pole transformers installed. By 10:30 A.M., just 4½ hours later, WTPA was back in business, operating on the 480-volt service.

Testing of the transmitter and its associated equipment began on August 13. First the water system was completely checked out, flushed and declared sound. Power then was applied to the high-voltage transformers and a complete check of the high-voltage system was performed. One bottleneck developed at this point; the water columns had not been delivered for the final cavities, however, they were delivered on the following day. These were installed immediately and early on the morning of August 15 the complete, final checkout of the system was performed. Fortunately, everything had been previously checked out and there were no bugs to be found. On August 15, at the start of the day's operations, WTPA put into operation its TTU-25B transmitter.

FIG. 4. Power equipment for operation of 25-kilowatt transmitter. Modifications called for changing primary service from 230 to 480 volts.



FIG. 5. WTPA transmitter building. A standby tower and antenna were used during conversion.

### Advance Plans

#### Simplify Antenna Installation

A stand-by tower and antenna were erected south of the WTPA transmitter building and operations were shifted to this location, so that the original 400-foot guyed structure which supported a TFU-27B antenna could be removed and a larger tower erected to support the new high-gain antenna. Meanwhile, transmitter conversion was undertaken despite the fact that a TFU-46AL antenna was not immediately available. A special temporary authority was granted by the FCC permitting WTPA to operate with a 5-to-1 power ratio between visual and aural transmitters, thereby permitting the high visual ERP produced by the TTU-25B transmitter. Originally the tower base was made large enough to support the new tower and antenna, hence, a tremendous saving was effected because the tower base and guy anchors could be used for the new tower. A TFU-46AL antenna was installed on the new 400-foot tower, completing the facilities for megawatt operation.

#### Transmitter Building

##### Houses New Equipment Without Change

Original plans for the transmitter building provided sufficient room for expansion. The block diagram, Fig. 6, shows how each succeeding modification was accomplished without additions to the building. In each case a section of false wall,

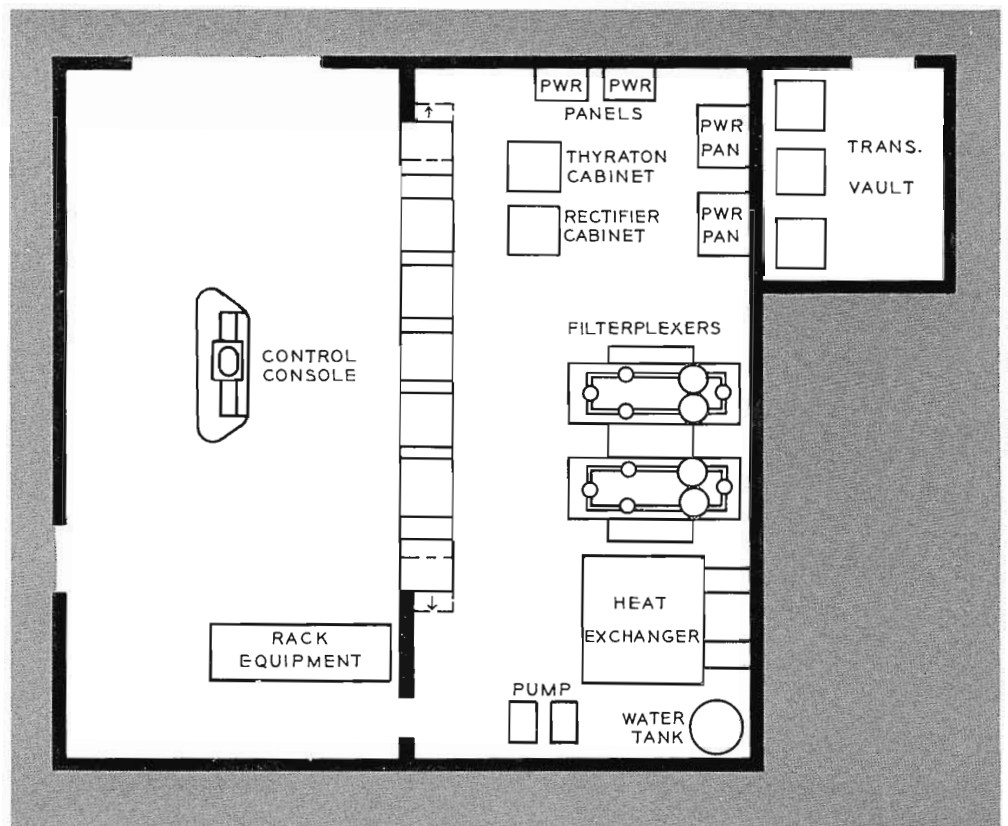

FIG. 6. Block diagram showing how modifications from 1 to 12 to 25 kilowatt transmitter were accomplished without additions to the building.

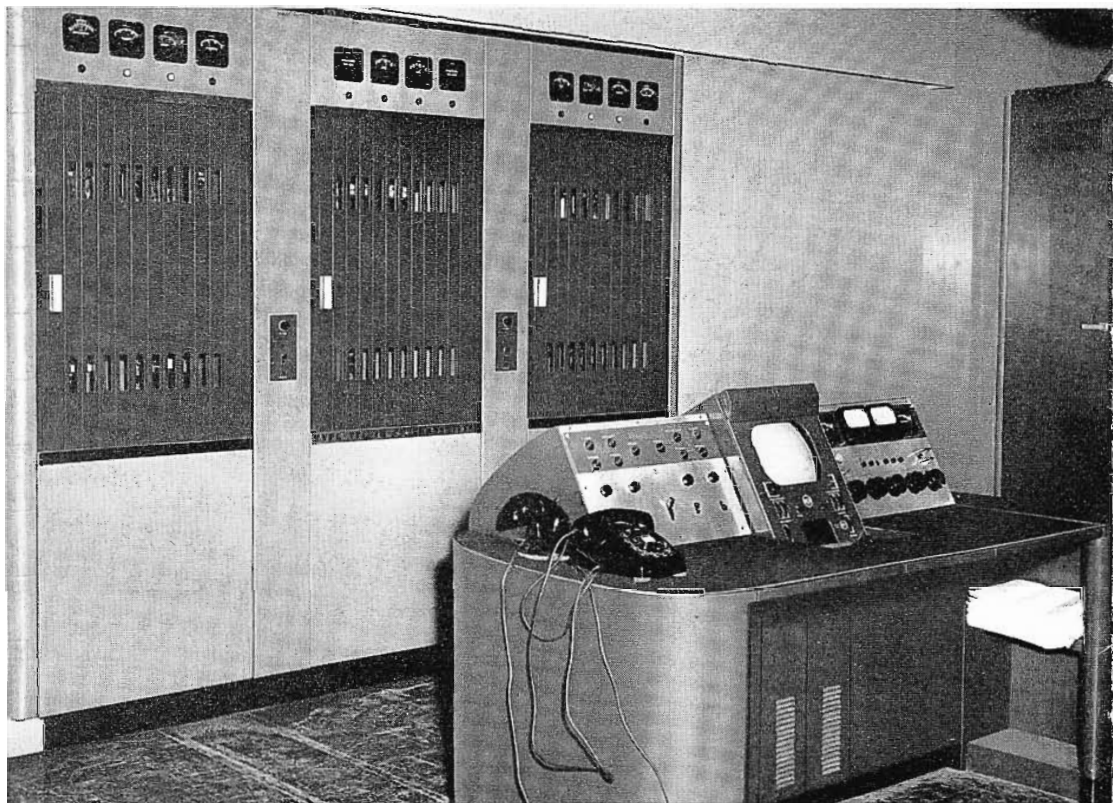

FIG. 7. Initial 1-kilowatt transmitter installation. A false wall provided room for expansion.



FIG. 8. The 12-kilowatt transmitter installation. The false wall has been removed to provide space for the extra cabinets.



dividing the building into two parts, was removed to accommodate additional transmitter cabinets. In Fig. 7 the initial one-kilowatt installation is pictured. Figure 8 shows the 12-kw installation, and Fig. 9 the 25-kw installation.

The transmitter building is located on Blue Mountain overlooking the Susquehanna River and the city of Harrisburg. It is a 30 by 80-foot building with the transmitter room itself measuring 30-foot square. The TTU-25B transmitter is installed down through the middle of this room. A false wall is built around the transmitter, separating the operating room with

control console from the rear of the building where the filterplexer, water-cooling system, thyatron and rectifier cabinets and other associated equipments are installed. The transformers are installed in a row (see Fig. 6) within a vault at the back of the building. Standard 4-by-4-inch ductwork, (as supplied by RCA on the original TTU-12 installation), is used to carry the primary and secondary voltages to and from the vault.

The remainder of the transmitter building houses a shop, kitchen, bedroom and lavatory areas. A three-car garage is located at the one end of the building.

FIG. 9. The 25-kilowatt transmitter installation. No new cabinets have been added, however, spacing of the cabinets has been changed slightly to make room for the water columns.



### Elevated Control Room Serves Two Studios

The studio building at 3255 Hoffman St., in uptown Harrisburg, houses WTPA offices, studios, control and film rooms as well as storage and workshop areas. The building measures 80 by 100 feet and includes two operating studios. Largest of the studios is Studio A, measuring 35 by 55 feet. A smaller area, Studio B, measures 21 by 31 feet. Both have 14-foot ceilings. Large double doors at the end of Studio A allow automobiles to be driven into the studio and provide easy access for large properties. Studio equipment includes three field camera chains, Type TK-31, which may be used in either or both studios, or in the station's mobile unit, a converted bus shown in Fig. 13.

The control room is elevated above the studios by a height of four feet. It measures 20 by 30 feet and contains extra large windows which look into each of the studios (see Fig. 12). The control desks include two film camera controls, remote control panels, switcher and line monitor as well as portable control units for the three field cameras. Built into the wall along the front of the desks are six monitors, providing signals off-air, from the three live cameras and two film cameras. The location of the monitors, immediately above the set of windows which look into Studio A, provides an unobstructed view to all program and



FIG. 10. Studio A, largest of the station's two studios, accommodates several sets and has access for automobiles and large properties.

FIG. 11. Studio B is used for weather, news and other small set programs. Shown are Tom Weitzel, Staff Announcer (left), and Donald D. Wear, Station Manager behind desk. Cameraman is Bob Hice.

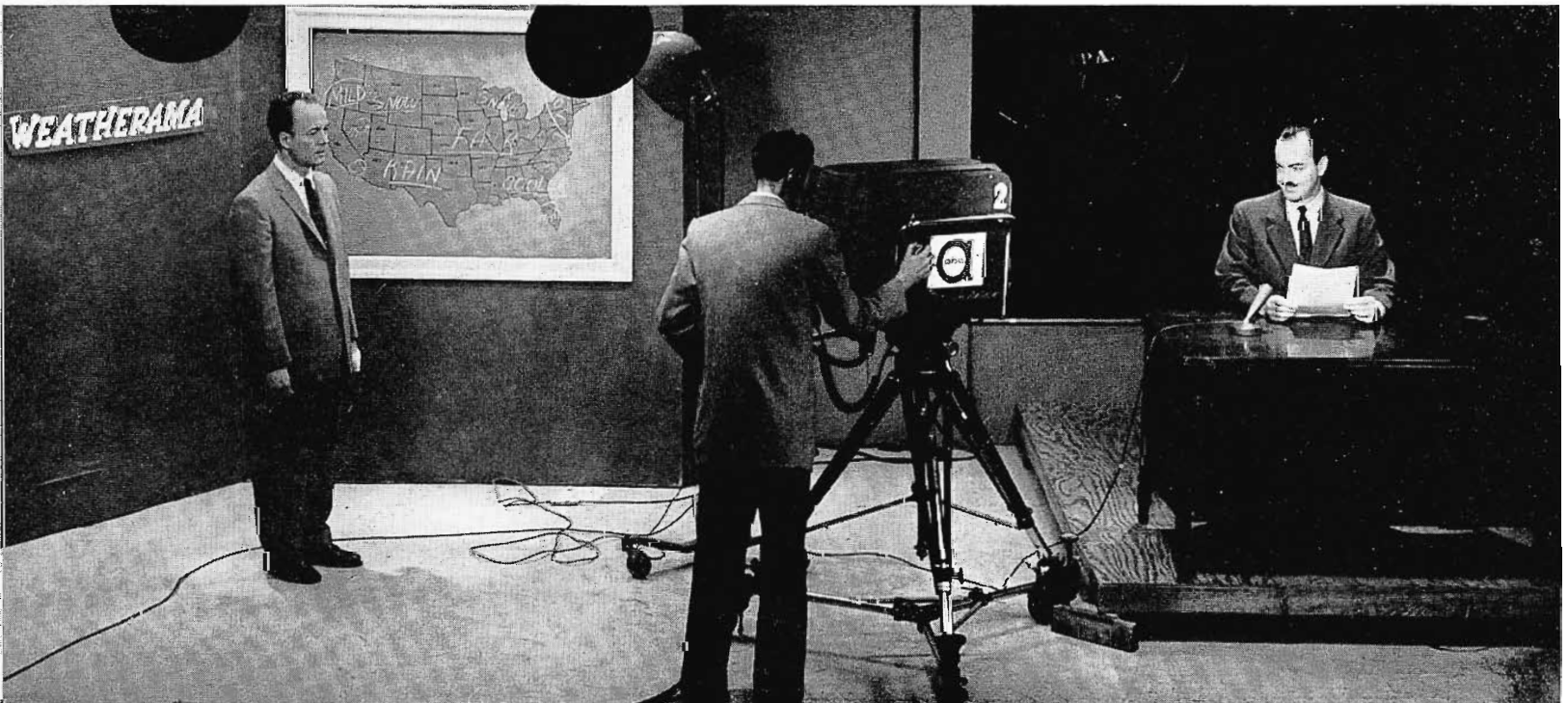

technical personnel. Also housed in the control room are all the lighting controls for both studios—a 90-circuit Rotolector panel and electronic dimming board.

Directly below the control room is a projection room (having the same dimensions as the control room). The area is equipped with two complete RCA film camera chains.

Ample room has been allowed in the studio building for storage and construction areas. The entire back portion of the building, the full width of 80 feet and a depth of 25 feet, has been allocated to set storage and construction. This area is provided with large overhead doors so that the station's mobile unit can be driven into this area.



FIG. 12. The WTPA control room includes portable control units for three field cameras and controls, and two film cameras. Also housed here are lighting controls for both studios.

### Initial Planning Pays Off

The initial planning and layout preparation along with careful consideration of future developments has enabled WTPA to take the successive steps from low to high power UHF operation most efficiently and economically. Each increase in power has been accomplished without building modification. The tower base was initially designed so that it and the guy anchors could be used with the station's new tower and ultragrain antenna. Thus, we reduced the number of man-hours required for the conversion and kept our station on-air all during the conversion.



FIG. 13. WTPA mobile unit. Field camera chains have been selected so that they may be used either in the studios or with this mobile unit.

FIG. 14. View from control room looking into Studio A during local production of weekly "Capitol Correspondents" program. Guest at telecast shown was Harold E. Stassen.

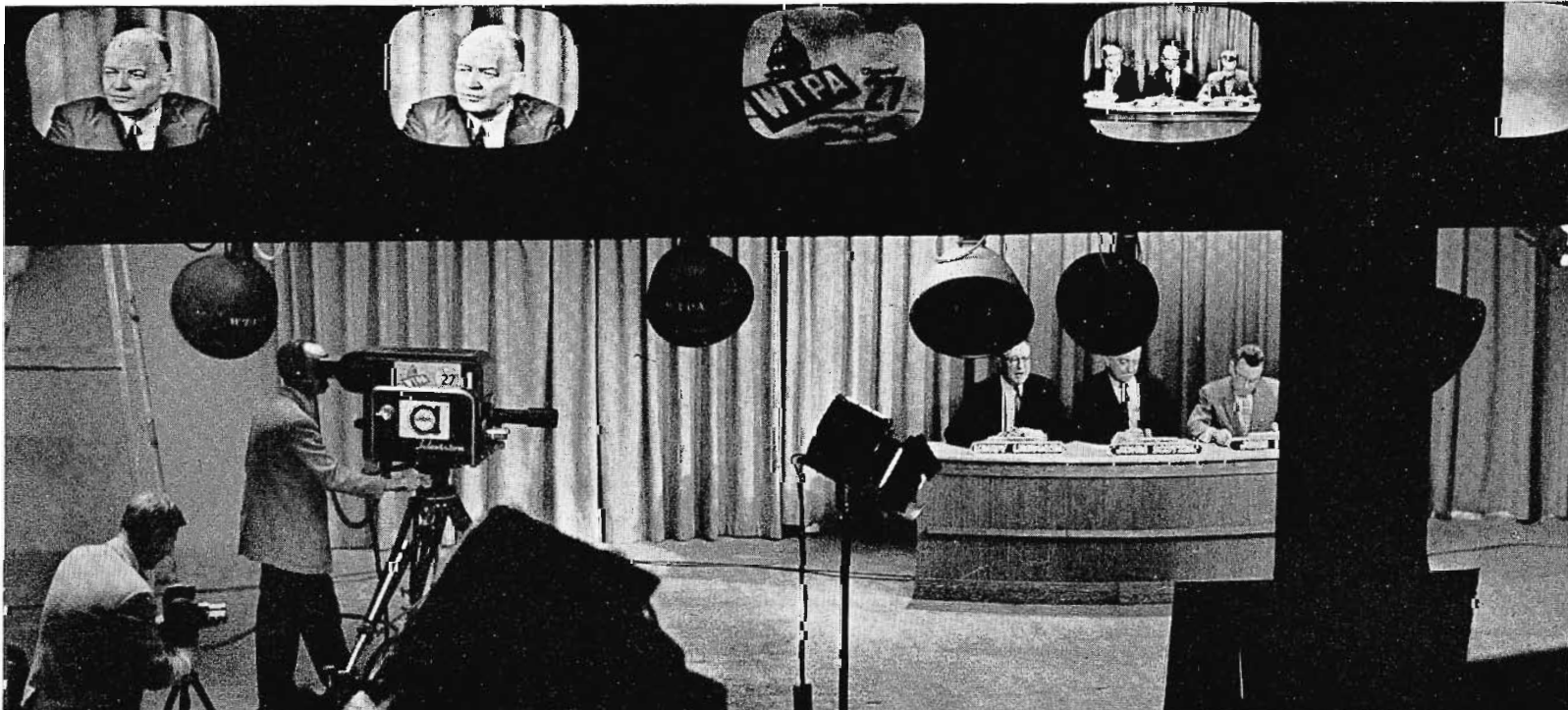

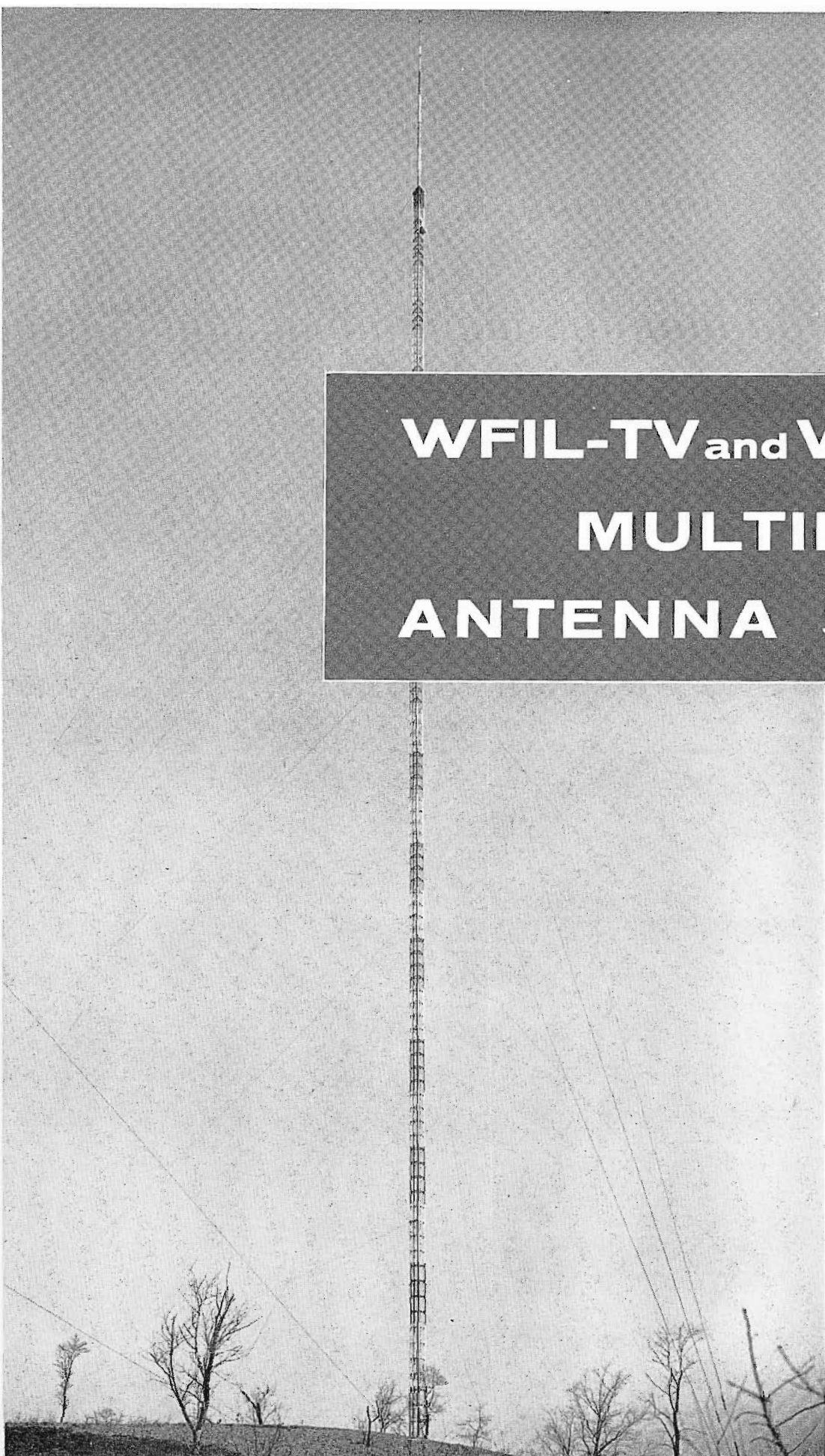

FIG. 1. Over-all view of the new WFIL-WRCV joint tower. The structure is 917 feet high, and the antennas increase the total height to 1109 feet.

## WFIL-TV and WRCV-TV MULTIPLE ANTENNA SYSTEM

The key outlet of Triangle Publications, Inc., WFIL-TV, and the local NBC station, WRCV-TV, have combined facilities atop a new 1109-foot tower in Roxborough, the highest point in Philadelphia. Both stations estimate that an additional 279,000 homes have been added to their service area that now extends to Asbury Park, N. J., to Stroudsburg and Mahanoy City, Pa., and to Havre de Grace, Md. Service has been greatly improved in the Philadelphia area, and better reception is apparent in the Allentown-Easton section of Pennsylvania.

Stations WFIL and WRCV jointly presented a special half-hour colorcast on December 15, 1957, to inaugurate operation of the new antenna system. The program, titled "The Big T," explained the increased benefits of a multiple tower, and in laymen terms showed how the TV signal is transmitted. During the program the public was given a close-up inspection tour, via TV, of the new tower, also a ride on the two-man elevator that runs up and down the side of the tower. A representative of the City of Philadelphia welcomed the mayors of ten other cities that have joined the increased viewing audience of the stations.

### **Philadelphia Stations Combine Antenna Facilities to Increase Coverage and to Improve Picture Quality**

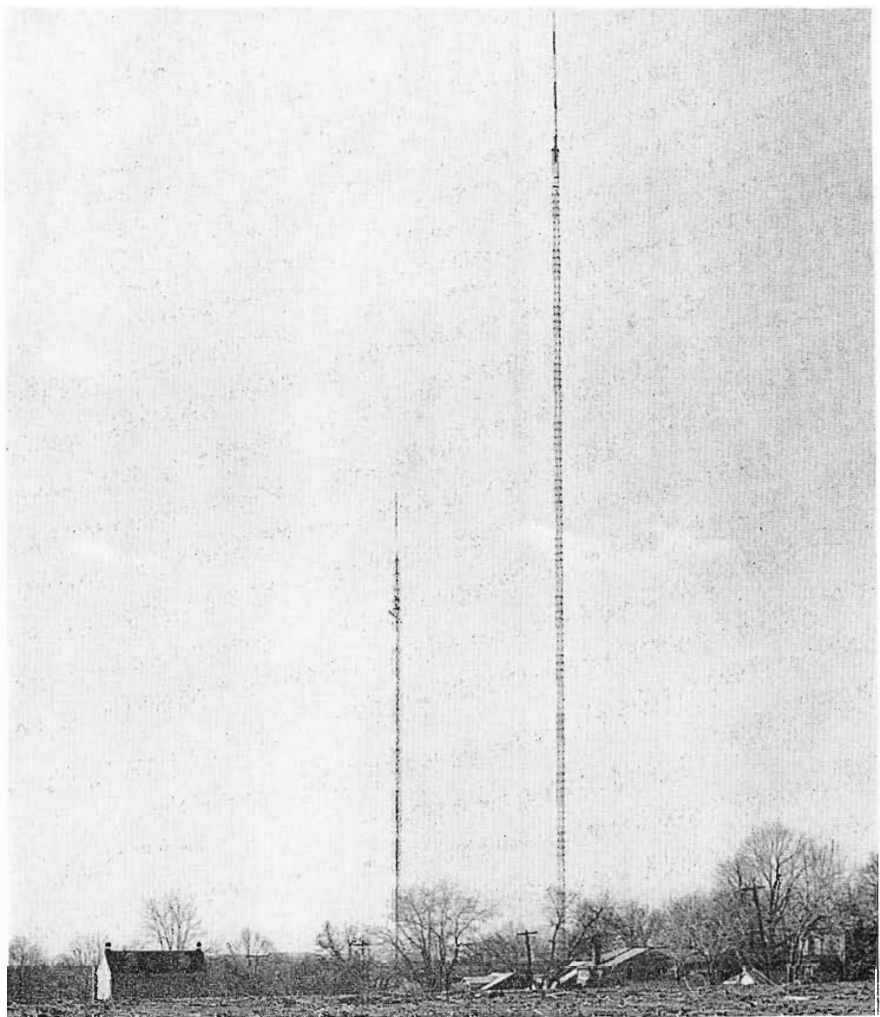

FIG. 2. The new 1109-foot tower is shown in comparison to WFIL's former tower structure.

FIG. 3. The WFIL-TV Type TF-6BM Superturnstile Antenna being raised to top of tower. Note the 1000-watt beacon on top of the antenna structure.

#### **New Antennas**

Station WFIL installed a Type TF-6BM Superturnstile Antenna, which is fed with the new  $3\frac{1}{8}$ -inch Universal Transmission Line. This six-section superturnstile is phased to provide uniform coverage with excellent null fill in. With an antenna gain of 8.13 db, WFIL continues to operate at maximum power atop the new tower.

Station WRCV selected a Type TF-6AL Superturnstile Antenna, which is split in half electrically. Provisions have been incorporated to feed either the upper or the lower three sections of the antenna in an emergency. In normal operation WRCV uses all six sections with a power gain of 7.85 db. The TF-6AL also provides excellent null fill in and uniform coverage.

#### **Tower Structure**

The entire 917-foot tower was fabricated by Dresser-Ideco, and shipped to Philadelphia in six trucks. The remaining 192 feet (the total height of the structure is 1109 feet) is made up of the TF-6BM and TF-6AL antennas. Approximately two miles of steel sections are used in the tower, if laid end to end, and weigh over 300,000 pounds; when combined with antennas the total weight of structure is 421,000 pounds.

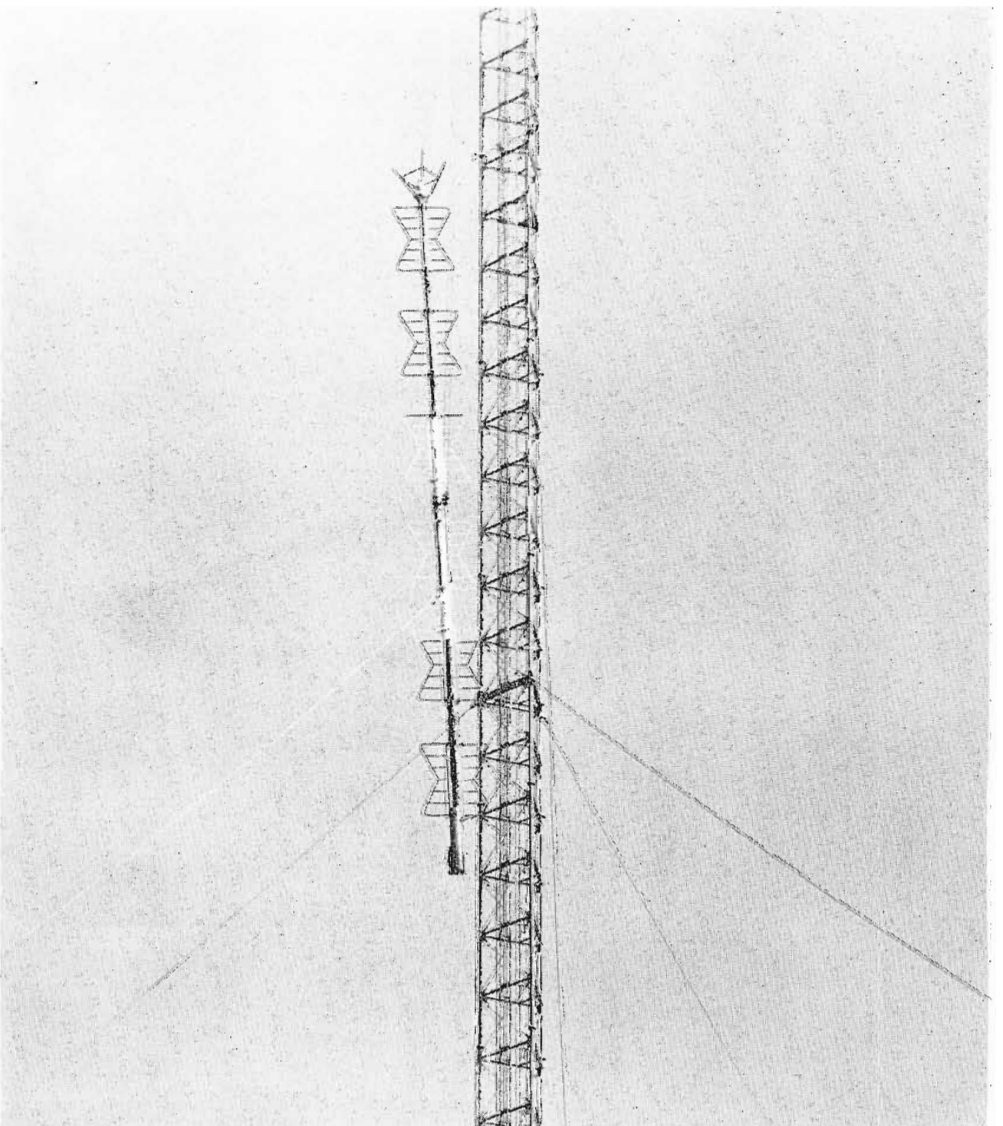
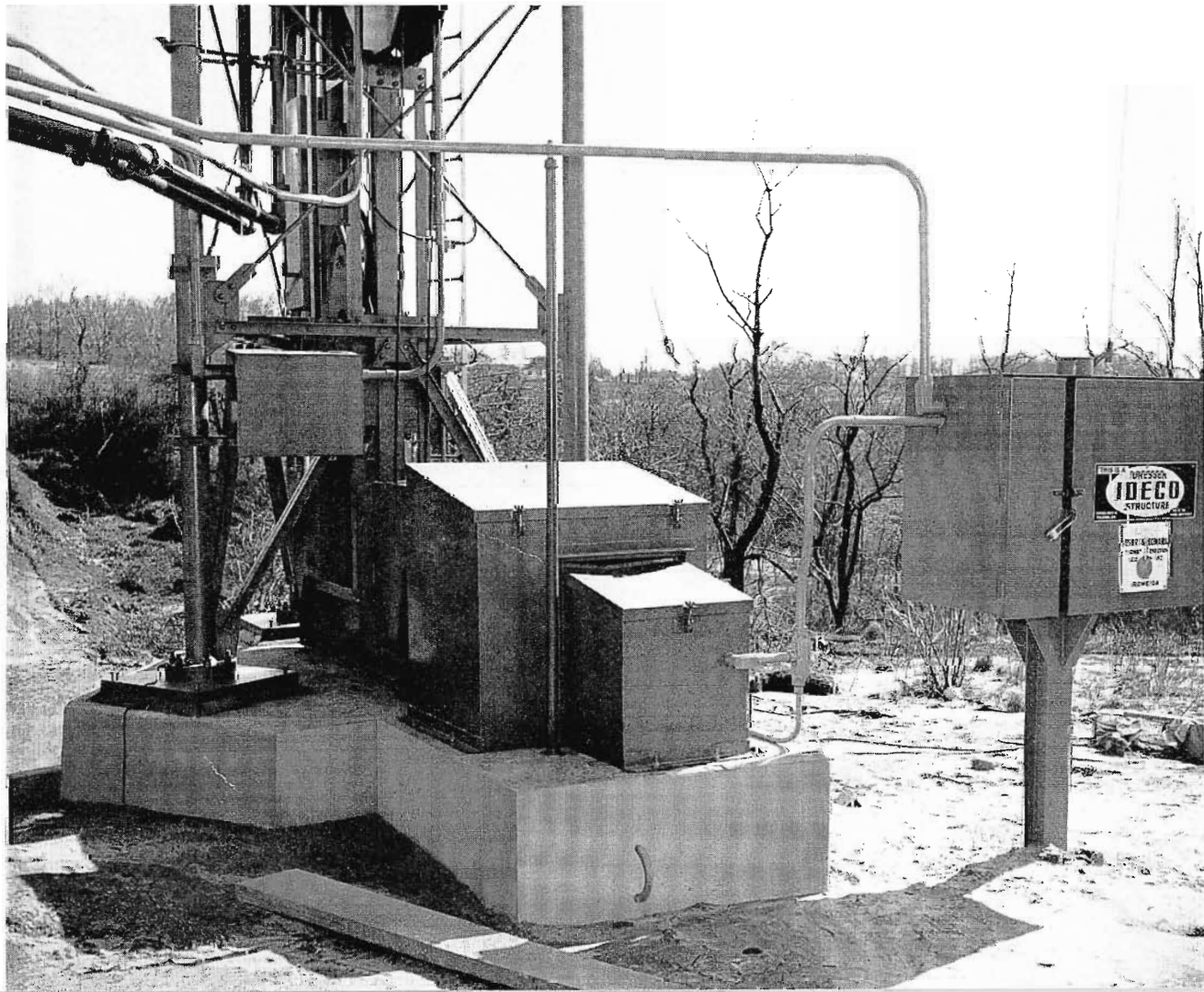



FIG. 4. Base of tower is an 11-foot deep, reinforced concrete foundation, six feet square with only two feet extending above ground. The two-man, radio-controlled elevator, noted by letter A, is shown in above photo.

FIG. 5. Another view of the foundation showing the transmission line feed from WRCV. Cabinet at right contains the tower-lighting control and the radio-control unit for the two-man elevator.



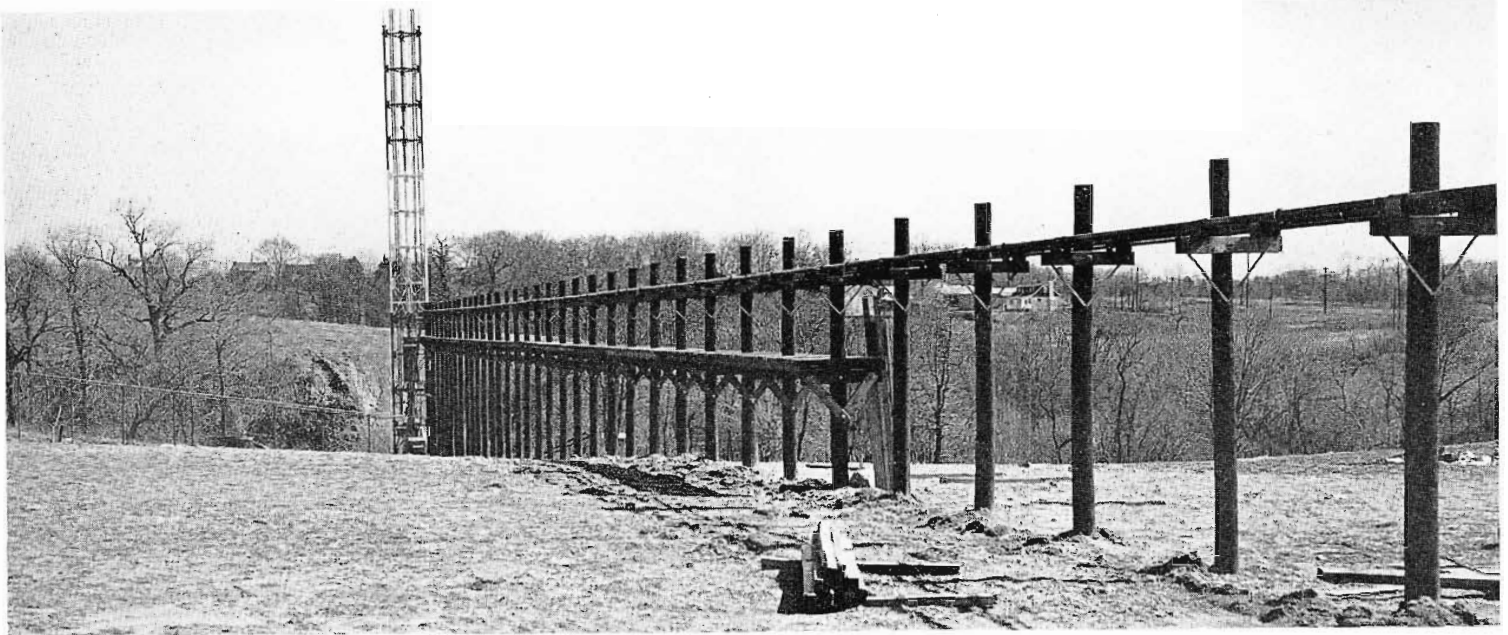

FIG. 6. WFIL constructed these support posts for the new 3 1/8-inch Universal Transmission Line. The line runs approximately 600 feet from the WFIL building.

### Tower Supports

Fifteen guy wires support the 917-foot tower. Two and one half miles of galvanized stranded bridge cable is used to guy the tower at five levels. The upper guy cables at 917, 630, and 420-foot levels are anchored at a point 700 feet from the base of tower. The two lower guy cables are on the 360 and 180 foot levels, and these are anchored 465 feet from the tower base. The guys are anchored in a 15-foot concrete foundation, 11 feet of which is underground.

### Tower Foundation

The triangular tower is 7 1/2 feet wide on each face, and it is set on a hexagonal foundation. The 11-foot, 2-inch deep reinforced concrete foundation is 6 feet on each side, and only 2 feet of the base is above ground. The tower legs are secured to the foundation with three leg bolts imbedded deep in the reinforced concrete foundation.

### Tower Maintenance

A radio-controlled, two-man elevator provides transportation to within 50 feet of the WRCV antenna. The enclosed-cab elevator control is operated by a battery-powered transmitter located in the cab. This transmitter sends stop-and-go signals to a receiver on the ground. In the event of cable failure, an automatic safety, locks the elevator to the guide rails.

Rest platforms are located at the obstruction and beacon light levels to make maintenance easier. The platforms allow a man to make needed repairs swiftly and safely.

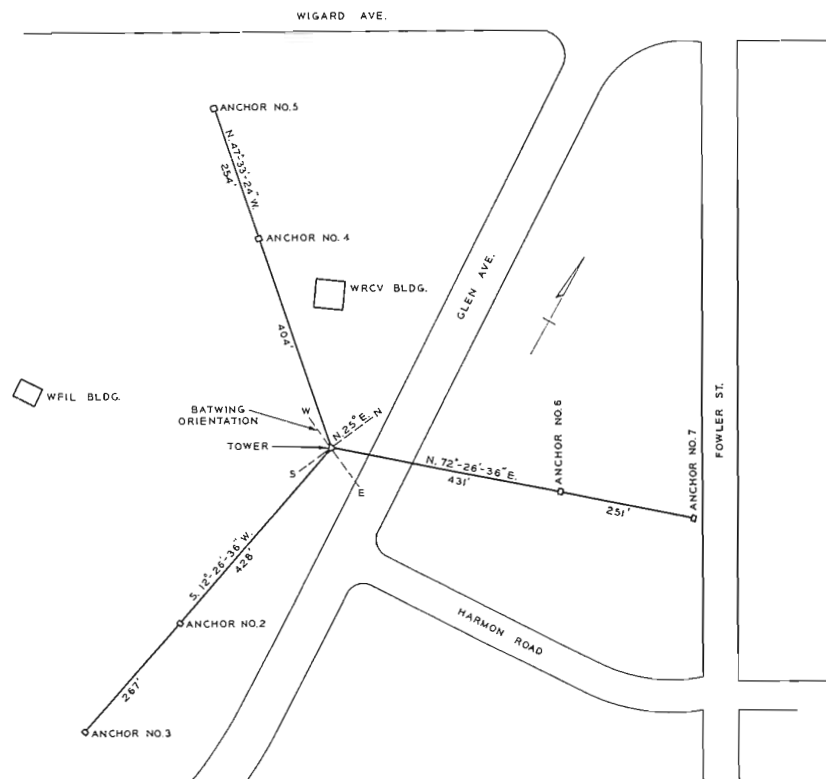

FIG. 7. Layout of WFIL and WRCV buildings with respect to the tower is shown.

A platform is also located at the ground level elevator landing, and an enclosed platform has been placed at the top elevator landing (872 feet high).

### Tower Lighting

The height of the structure and its location demand strict compliance with CAA lighting regulations. However, a joint antenna does reduce the hazard that would

be created if these stations were on separate towers. A flashing 1000-watt beacon is mounted on top of the WFIL, TF-6BM antenna with other 1000-watt beacons mounted at the 810, 540, and 270-foot levels. One-hundred-watt obstruction lights were placed on the 150, 420, and 690-foot levels; an additional set of two 100-watt obstruction lights was placed on the WRCV antenna.



FIG. 8. WFIL continues to use existing facilities which are considered more than adequate. A complete workshop and a small kitchen are found here in addition to all transmitting equipment.

### New Equipment

Station WFIL installed the new  $3\frac{1}{8}$ -inch Universal Transmission Line. This type of line operates uniformly over all channels with low loss and high efficiency. Station WRCV installed a new Type TT-6AL Transmitter to drive its existing 25 KW amplifier, and another TT-6AL as a stand-by unit.

The new tower site is located a few hundred yards from the former WFIL tower. On the other hand WRCV moved from its former site in Wyndmoor, Pa., to a new building at the present site. While WFIL continues to use its existing facilities, located about 600 feet from the new tower, WRCV's new building is approximately 200 feet from the tower.

### Co-operation Pays Off

Both stations are proving by this venture that co-operation does produce greater benefit by improving their picture quality and coverage. Since both WFIL and WRCV are equipped for live local color, this new joint antenna has also done much to strengthen color quality. Furthermore, the viewers as well as the stations benefit from this joint installation: the viewers receive better pictures, and the stations split the costs of installation.

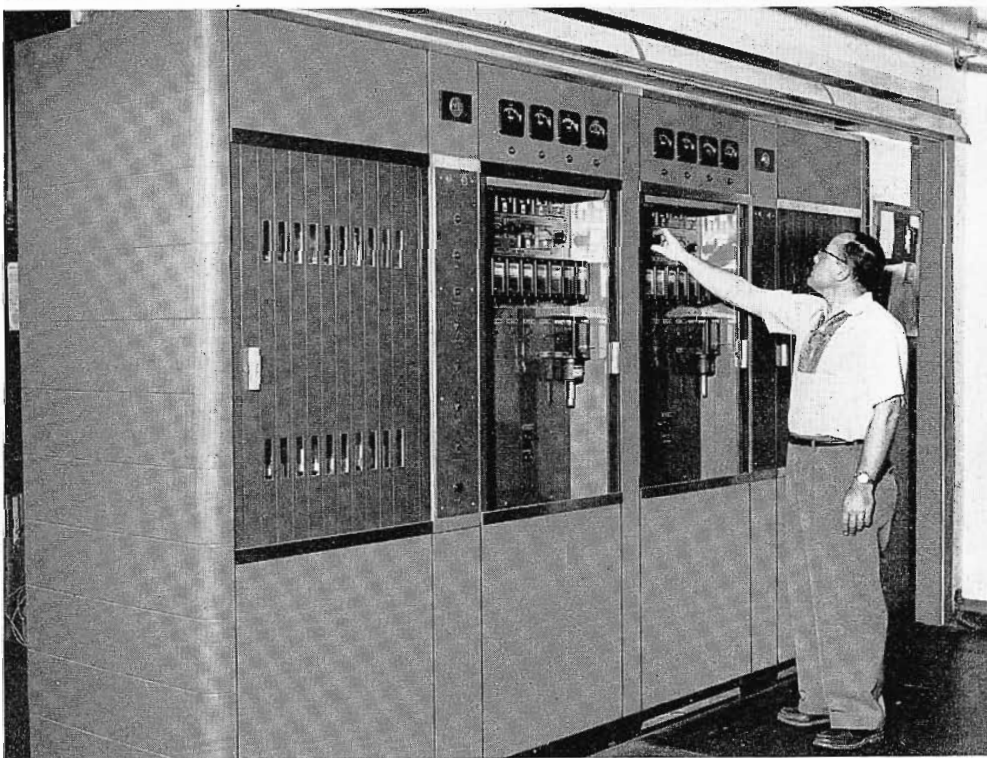

FIG. 9. Edward Neville, WFIL Transmitter Engineer, checks the TT-25BL amplifier.

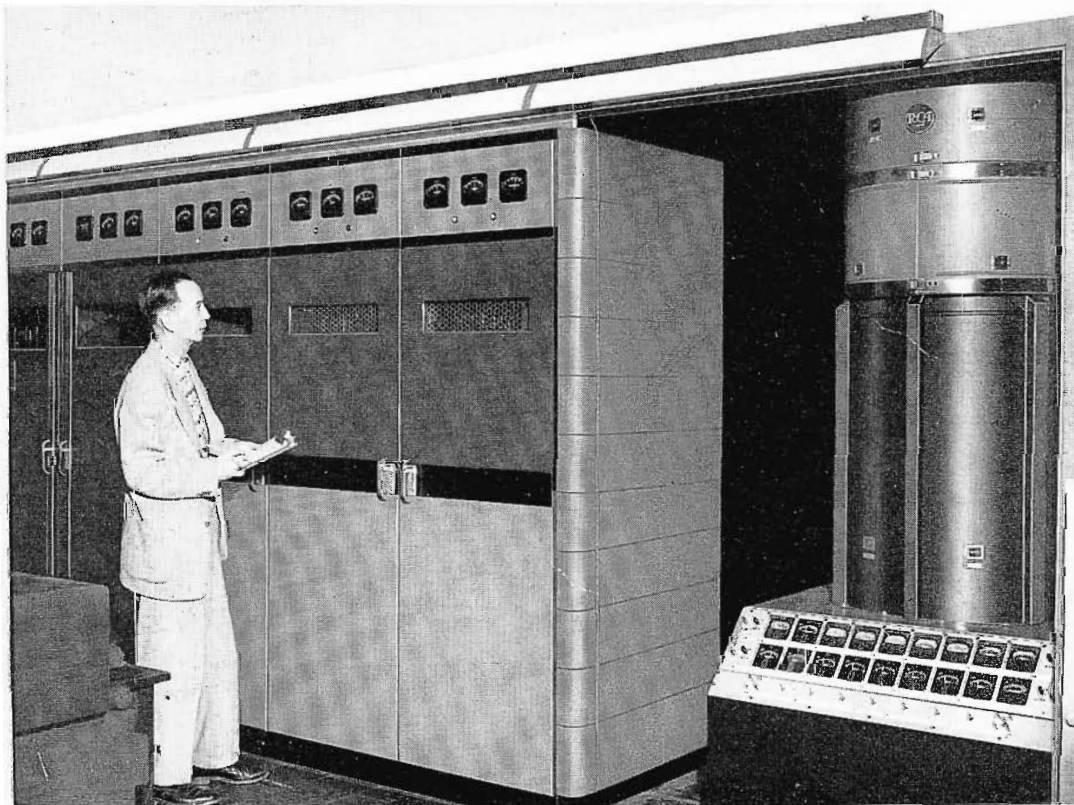

FIG. 10. Richard Marshall, WFIL Transmitter Supervisor, takes readings on the TT-5A driver. A TT-25BL amplifier is shown on the right.



FIG. 11. WRCV-TV has constructed this new transmitter building that incorporates many desirable features, including a garage, a complete workshop, a complete kitchen, and ample office area.



FIG. 12. Co-operation does pay off. Left to right: Fred Everett, Station Engineer, WRCV-TV; William A. Howard, Manager of Technical Operations, WRCV, WRCV-TV; Henry Rhea, Director of Engineering for Triangle Stations; Richard Marshall, Transmitter Supervisor, WFIL-TV. These engineers have worked together to make this a joint installation.

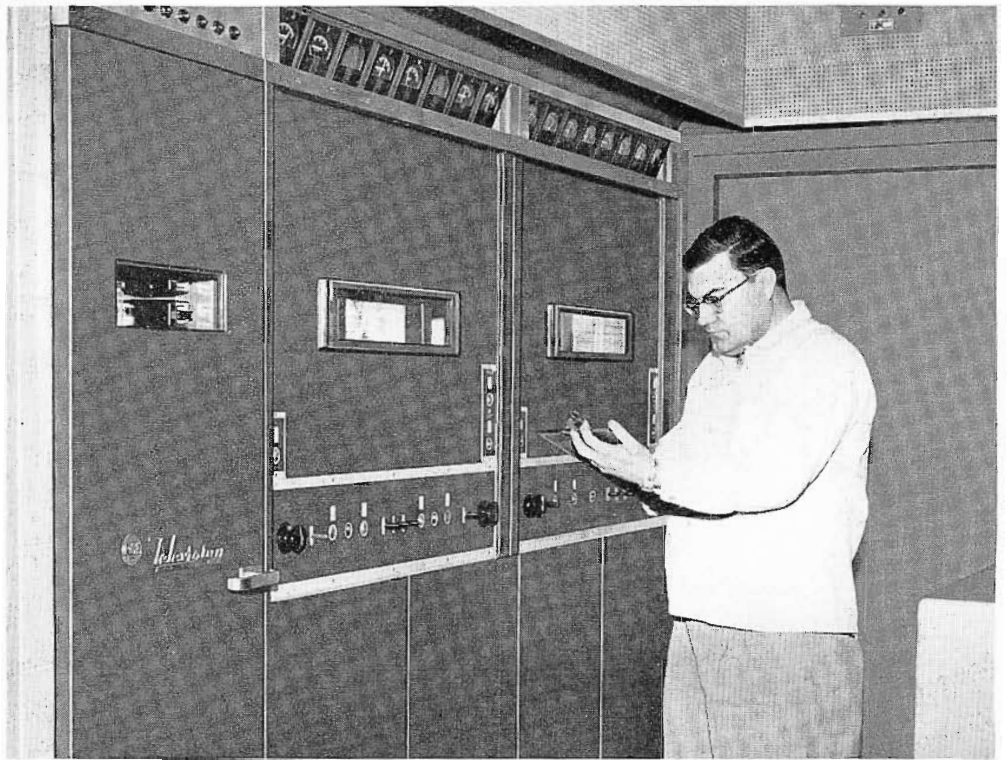

FIG. 13. Oscar Jimerson, WRCV Transmitter Engineer, takes readings on one of WRCV's new TT-6AL drivers.

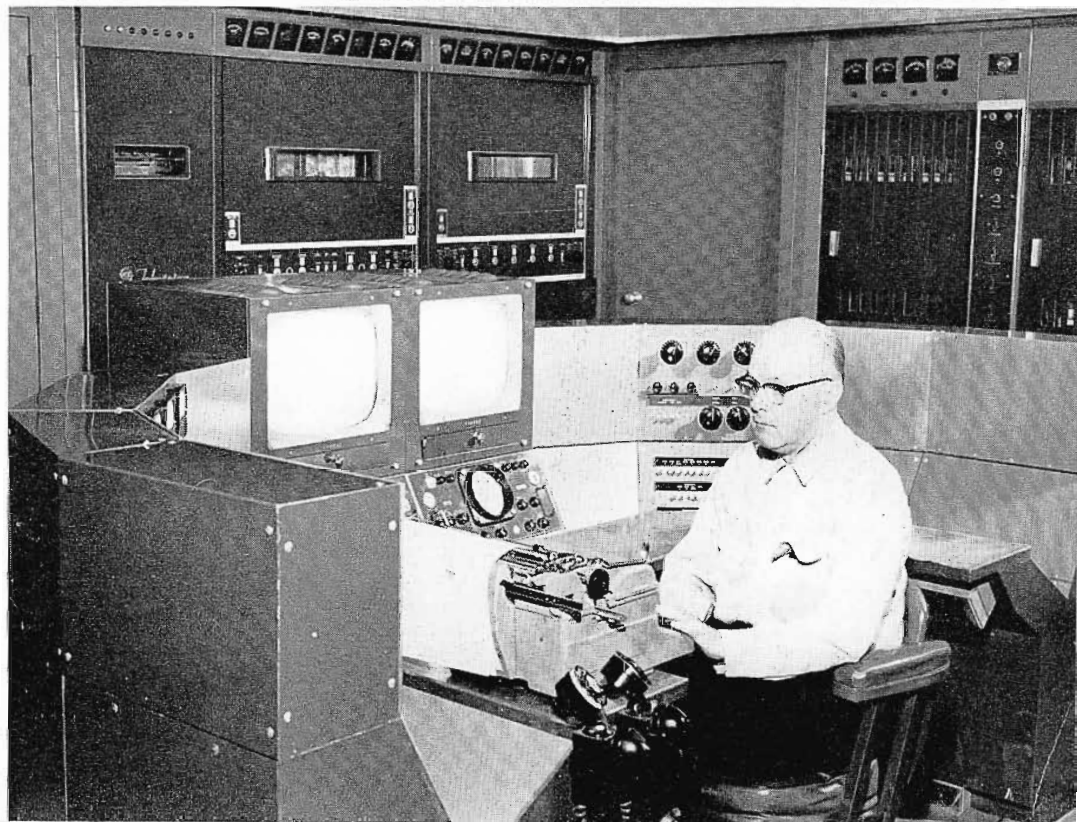

FIG. 14. Henry Shaw, WRCV Transmitter Engineer, on duty at the custom-built WRCV transmitter control console.

# THE APPLICATION OF VERY PRECISE TELEVISION COCHANNEL INTERFERENCE

by WENDELL C. MORRISON, Chief Engineer, Telecommunications Division

## ABOUT THE AUTHOR



Wendell C. Morrison came to RCA in 1940 as a Student Engineer after receiving the MS Degree in EE from the State University of Iowa. He joined the Research Department and moved to the RCA Laboratories in Princeton, New Jersey, when that organization was established in 1942. Here he worked in the fields of speech privacy systems, antennas, antenna pattern calculators, utilization of radio frequency power, television transmitters, and television terminal and test equipment. He participated in the development of color television and was active in the work of several panels of the National Television System Committee.

In 1957, Mr. Morrison returned to Camden as a Staff Engineer to the Chief Engineer, Industrial Electronic Products. On January 16, 1958, he was appointed to his present position as Chief Engineer, Telecommunications Division, I. E. P.

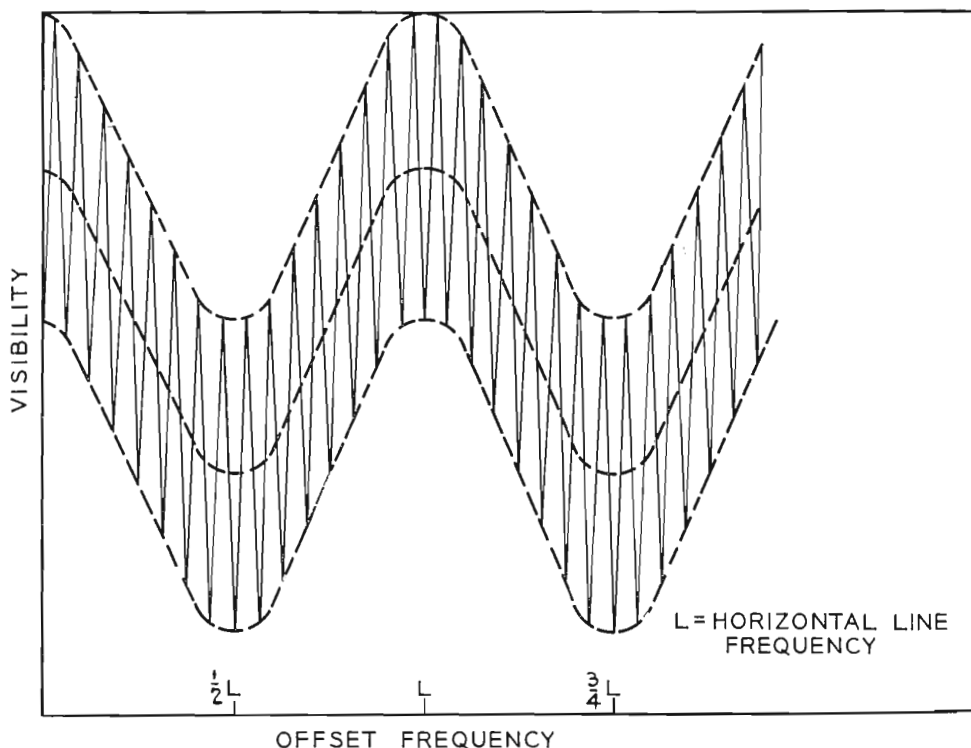

FIG. 1. The offset of cochannel visual carriers is shown; note the fine structure that is superimposed. The maxima and minima points occur at multiples of one-half the line frequency.

The first television channel assignments made in this country utilized the geographical separation between stations to provide the necessary protection against cochannel interference. The increase in the number of stations, together with the gradual increase in power of the stations, demonstrated that the original plan was not entirely adequate. The search for a method to minimize cochannel interference resulted in our present system of allocations, which utilizes an offset between visual carrier frequencies of cochannel stations. Recently, it has been demonstrated that precise frequency control is of real value in reducing this interference and that it is practical to make stable oscillators to be used for this purpose with television transmitters.

## Present System

Early experiments demonstrated that the greatest amount of improvement is obtained when the offset frequency is near an odd multiple of one-half horizontal-line frequency of the television system, while the greatest amount of interference occurs when the beat is an even multiple of one-half horizontal-line frequency. To make a practical system in which more than two cochannel stations are involved, it was necessary to make a compromise between these two values. The present system fixes one station on the nominal carrier frequency; the second station 10 kc higher; and a third station 10 kc lower. This makes the beat between the second and third stations 20 kc which gives essentially the same improvement between each of the three stations.

At the time these early experiments were performed, it was noted that an additional improvement could be obtained for certain frequencies near the 10 and 20 kc offsets, but the frequency tolerance required was so small that the existing methods of transmitter frequency control made it impractical to try to utilize this additional improvement. An illustrative sketch show-

# FREQUENCY CONTROL TO MINIMIZE

## PART I

### THEORY OF OPERATION DESIGN OF STABLE OSCILLATORS EXPERIENCE IN THE FIELD

ing this trend is illustrated in Fig. 1. It will be noted that in addition to the maxima and minima occurring at multiples of one-half line frequency there is a fine structure superimposed.

#### Recent Investigations

Recent advances in the art of manufacturing quartz crystals with long term stability along with novel circuitry for making crystal oscillators independent of circuit components other than the crystal, made a re-evaluation of the cochannel interference problem worthwhile. The first step was a detailed investigation of the improvement that could be obtained if the fine structure noted in Fig. 1 could be utilized. A laboratory setup was made, and statistical data was obtained. Figure 2 shows the characteristics around 10,000 cycles and Fig. 3 the characteristics around 20,000 cycles. These curves show the required difference in decibels between the desired signal and the undesired signal in order to obtain a tolerable picture for the offset frequencies shown. It can be seen that an improvement of at least 10 db can be obtained at each of the two offset frequencies.

A more important observation is that in the region of maximum improvement the desired signal need be only 21 db stronger than the undesired to produce a tolerable picture. This variation in interference is not unique for the frequencies shown. The curves are duplicated at frame frequency intervals and change slowly to conform to the variation related to line frequency as shown in Fig. 1. This gives a clue to the basis for the improvement obtained. The interfering signal is not reduced, but the beat pattern produced is related to both the television line and field frequencies in such a way as to interlace out or, in other words, to produce a fine-structure pattern which is less visible. This points out a basic requirement for the proposed system: the offset frequency must be related to the television line and frame frequencies. Specifically, for the frequency domain being

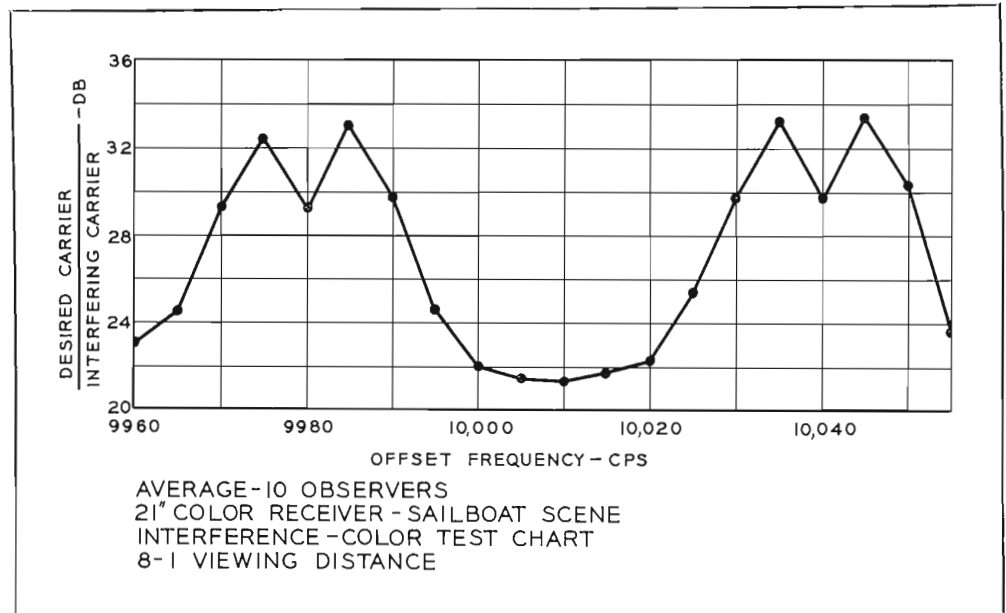

FIG. 2. The difference in db required to produce a tolerable picture with carriers offset by approximately 10 kc.

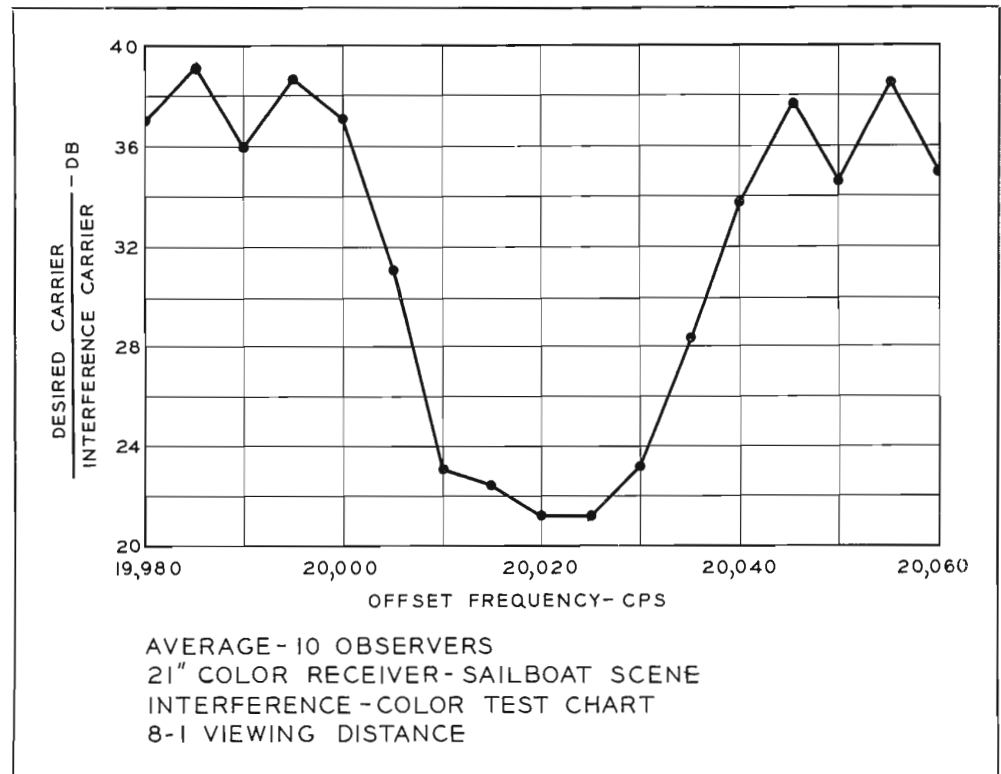

FIG. 3. Note the difference in db required to produce a tolerable picture with the carriers offset by 20 kc.

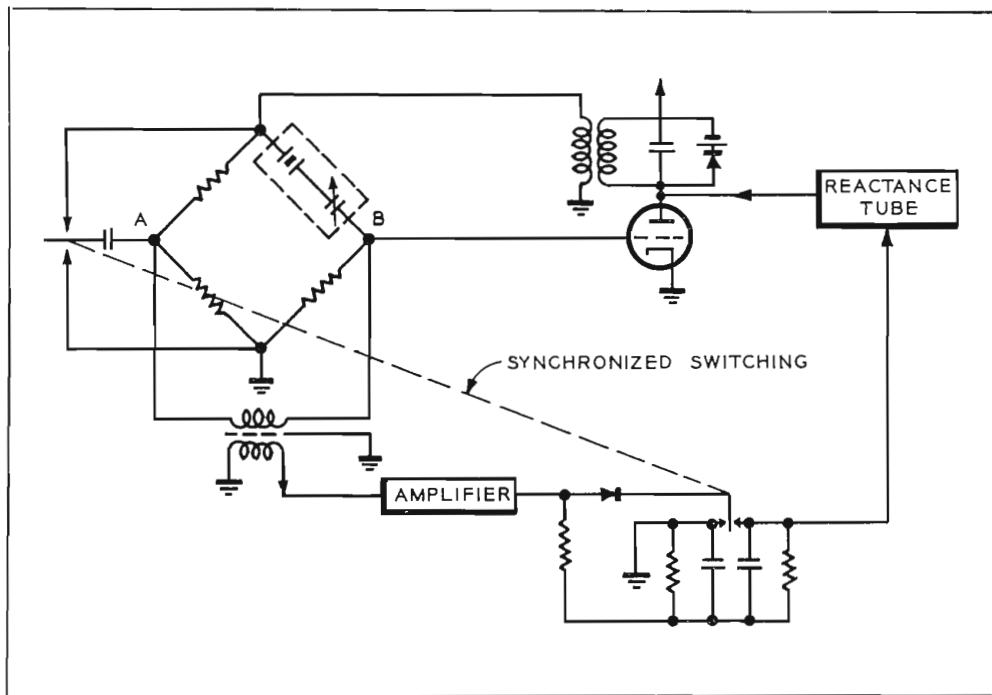

FIG. 4. Here is an oscillator circuit that is stable enough to produce the required frequency control tolerances.

considered, the requirement is met by making the offset an even multiple of frame frequency. A simple method for providing the required stability of the field and frame frequencies is to lock the station synchronizing signal generators to a color sub-carrier frequency crystal. This equipment is commercially available, and already installed in many stations.

The indicated improvement can be used in two ways. If the separation between stations is unaltered, the use of precise frequency control will improve the pictures in areas where the quality is limited by co-channel interference. Where present quality is considered adequate, the use of precise frequency control would allow stations to be closer together without creating increased interference in the cochannel limited areas.

An examination of Figs. 2 and 3 indicates that the beat between the visual carrier frequencies should be maintained within  $\pm 10$  cycles to obtain the major part of the improvement possible. This allows a change of  $\pm 5$  cycles for each station. Thus it can be seen that the stability required varies from  $\pm 1$  part in  $10^7$  for the lower VHF channels to  $\pm 5$  parts in  $10^9$  for the higher UHF channels. The time during which this stability must be maintained without check or adjustment depends upon the period of time that is considered necessary for a practical system. A frequency check once a month is certainly not unreasonable.

#### Oscillator Stability Improved

Concurrent with the observational tests, work was started in the laboratory to produce crystal oscillators of the required stability. One oscillator that is capable of the required performance is shown in Fig. 4. In this circuit it will be noted that the amplitude of the oscillations is limited by a diode in the plate circuit. The plate circuit is decoupled from the crystal circuit by a transformer, and the grid circuit is isolated from the crystal by a low-value shunt resistor. This combination alone would make a reasonably stable oscillator.

The additional equipment allows the crystal to operate as a phase detector, in addition to its normal function as an oscillator. A reactive change in the circuit would normally cause a change in the frequency of oscillation, but with this circuit it will unbalance the bridge and produce a control voltage on the reactance tube which compensates for the original change. It is apparent that if a crystal with good long-term stability can be provided, the circuit will adjust automatically in an appropriate fashion to make the frequency of oscillation very stable.

Stable crystal characteristics can be obtained by first utilizing a crystal that has been manufactured with the best techniques commercially available, and then this crystal must be operated in a good, constant-temperature oven. One oven control circuit with the desired characteristics is shown in Fig. 5. Whenever the tempera-

ture of the bridge, which constitutes the heating element of the oven, is below the balance temperature, a small a-c signal is produced which is amplified and detected. This rectified signal is used to control the d-c supply which provides the power to heat the bridge. If the bridge overshoots and goes too high in temperature, the phase detector prevents additional power from flowing into the bridge.

#### Field Tests

Two crystal oscillators were built. One was installed at WRCA-TV, the Channel 4 station in New York, and the other was installed at WRC-TV, the Channel 4 station in Washington, D.C. The system was tested for several months. When the units were first installed, one oscillator was arranged so that during color shows (when line and field rates were accurately controlled) the offset frequency could be changed with the snap of a switch from one of the best frequencies near 10 kc to one of the poorest frequencies near 10 kc. The signals were observed at several locations between New York and Washington, during many different shows. Due to propagation differences, cochannel interference was not always a problem. However, when cochannel interference could be observed there was never a time when changing to the desired offset did not either clear up the interference or materially improve it.

Regarding the relative stability of the crystal oscillators, almost daily checks of the beat between the two signals were made at the David Sarnoff Research Center in Princeton, N. J. The results are shown in Fig. 6. It will be noted that for the first forty days considerable aging is apparent, since the beat changed by 5 cycles out of 67 million cycles. By this time the initial aging was essentially complete and the frequency remained quite stable for the next 20 days. At the end of this period it was decided to readjust the beat frequency to about 9950 cycles as shown. The next 15 days show an aging of only about one-half cycle. At this time one of the ovens became inoperative. Although the crystal kept oscillating, the unit was taken out of service. It was repaired, and restored to service 135 days after the beginning of the test. For the next two months there was very little aging and the frequency held within  $\pm 0.5$  cycle. Operation without adjustment continued for several weeks, beyond what is shown in Fig. 6, with essentially the same results. This represents a relative stability of  $\pm 4$  parts in  $10^9$  for each oscillator for a period of two months. Since this time, the two oscillators have been in continuous use for over

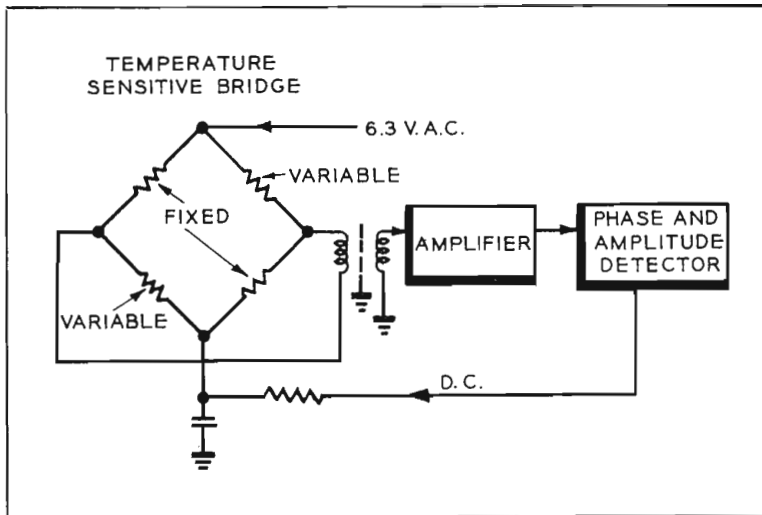

FIG. 5. Diagram of the oven-control circuit. Changes in ambient temperature unbalance the bridge and modify the power flow to keep the oven temperature constant.

a year with simple periodic frequency checks to maintain the offset.

#### Summary

Laboratory tests have established the fact that an improvement in the order of 10 db can be obtained with precise offset frequency control. In order to obtain reduced visibility of the cochannel interference, it is imperative that the beat frequency between the visual carriers be related in a particular fashion to the line and field rates of the video signal. With the required conditions established, this means that the desired signal need be only about 20 db larger than the undesired signal to produce a tolerable picture. It also has been demonstrated in the field that the system is effective under actual operating conditions. Two improved crystal oscillators have been built and operated which have a relative stability more than adequate for the VHF television channels. The reduction of interference obtained with this system can be used to move cochannel stations closer together, or to improve the fringe area service of existing stations when they are limited by cochannel interference. It is interesting to note that in such areas, if any station were to increase its service area by means of a power increase, additional viewers would be obtained at the expense of the cochannel stations. If the cochannel stations also increased their power by the same factor, the service areas would be back to the original condition. On the other hand, with the application of precise frequency control, each station

would obtain the same improvement as though it alone had increased its transmitter power.

#### Bibliography:

1. W. L. Behrend, "Reduction of Co-Channel Television Interference by Precise Frequency Control of Television Picture Carriers," RCA Review, Vol. XVII, p. 443, December, 1956.
2. G. L. Fredendall, "A Comparison of Monochrome and Color Television with Reference to Susceptibility to Various Types of Interference," RCA Review, Vol. XIV, p. 346, September, 1953.

3. RCA Laboratories Division, "A Study of Co-Channel and Adjacent-Channel Interference of Television Signals, Part I," RCA Review, Vol. XI, p. 99, March, 1950.
4. Norman Lea, "Quartz Resonator Servo—A New Frequency Standard," The Marconi Review, Vol. 17, p. 65, 3rd Quarter, 1954.
5. P. G. Sulzer, "High-Stability Bridge-Balancing Oscillator," Proc. I.R.E., Vol. 43, p. 701, June, 1955.

*Editor's Note:* In our next issue (June, 1958) we will present Part II which will be entitled "Equipment for Achieving Precise Frequency Control of Television Transmitters."

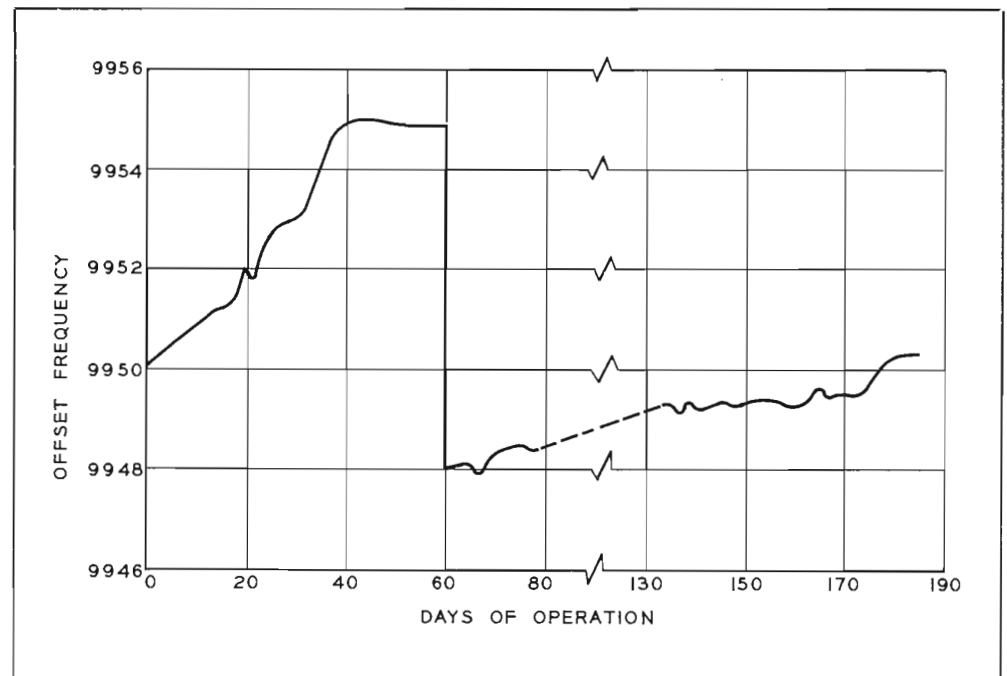

FIG. 6. Actual field tests were made with this system, and this graph indicates the relative stability obtained.



FIG. 1. Complete metering of all stages and simplified tuning are inherent characteristics of the BTA-500R and BTA-1R transmitters.

# NEW 500 AND 1000 WATT AM TRANSMITTERS

*Type BTA-500R and BTA-1R Provide Outstanding Performance; Provision for Remote Control; Ease and Economy of Operation, and Color Styling*

*by J. NOVIK, RCA Broadcast Sales*

The latest trends in broadcasting, calling for increased power, remote control, and Conelrad requirements, have dictated a new approach in transmitter design. As a result, RCA engineers have designed an altogether new AM transmitter that integrates these modern requirements but uses standardized circuitry. With this technique either the BTA-500R or the BTA-1R transmitter has the facility of simplified power change. Remote-control provisions

have been incorporated in both transmitters so that operational control is easily obtained by making proper connection to a remote-control unit. Also included in the design, with the addition of a few accessories, is remote Conelrad switching. While retaining all of the quality, performance and reliability contained in the previous RCA transmitters of the same power level, these new transmitters have many additional advantages.

FIG. 2. Attractive functional styling plus ease of access make the BTA-500R and BTA-1R modern economical transmitters.

## Features of Type BTA-500R and BTA-1R Transmitters

**No Neutralization Required**

**Built-in Provision for Remote Control**

**Bi-Level Modulation**

**Fewer Tubes**

**Accessibility**

**Simplified Tuning**

**Modern Styling**

Tetrodes throughout simplify the tuning.

Terminal strips are provided in the transmitter for connection of a remote-control unit.

The very low order of distortion results in improved soundability.

Smaller tube inventory means reduced cost of operation.

Vertical construction permits easy access for maintenance.

Only one tuning control—and it's on the front panel.

Fits into any surroundings through choice of color and functional design.





Burgundy Red



Peacock Blue

### Functional Color Styling

In hand with the modern day emphasis on functional styling, the BTA-500R and BTA-1R transmitters have been designed to combine an attractive appearance with the utmost in utility. Both the cabinet design and the colors will adapt themselves to various types of surroundings. The cabinet that houses the transmitter is made of aluminized steel, and this combination of metals fuses the electrical properties of aluminum with the strength of steel to provide a rigid, well-shielded cabinet. In order to provide an attractive appearance, and yet maintain functional operation, the two panels on each side of the door are designed to provide front panels for mounting all normal operating controls (see Figs. 1 and 2). This type of construction per-

mits installation of the transmitter against a wall, or allows other equipment to be placed on either side of the cabinet. As an additional and altogether new feature, the doors of these new transmitters are available in several colors: red, blue, green and dark umber gray—in order to harmonize with the colors of the surroundings. Since, in many cases, today's transmitter is located directly in the studio building, this emphasis upon styling and color lends luster to the appearance of a station.

### Ease of Access

Although there is no back door, access to the rear is provided through two interlocked panels behind the transmitter. These interlocked panels are easily removed with thumbscrew fasteners (see Figs. 3 and 4).

Vertical construction permits easier maintenance and service. The larger power components are mounted at the base of the cabinet. One beneficial electrical aspect of vertical construction is the unobstructed manner in which the air will travel upward, providing the most effective and uniform cooling.

The cabinet is 84 inches high, 34 inches wide and 32 inches deep. A 4-inch base on either the BTA-500R and the BTA-1R can be removed by taking out the three leg bolts on each side of the base plate. This removable base makes it easier to move the transmitter through doorways, and to fit it into existing transmitter buildings. Careful design has produced a rugged, well-shielded cabinet that will give years of outstanding service.



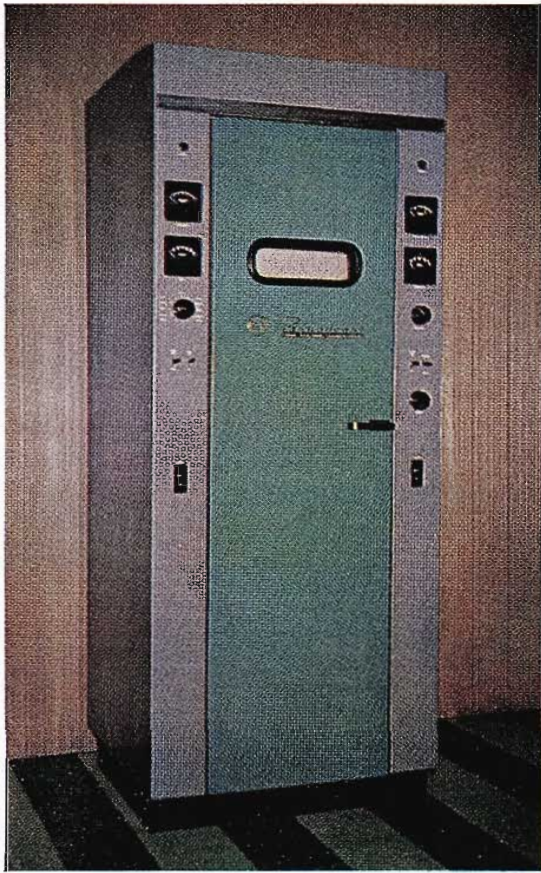

Emerald Green



Dark Umber Gray

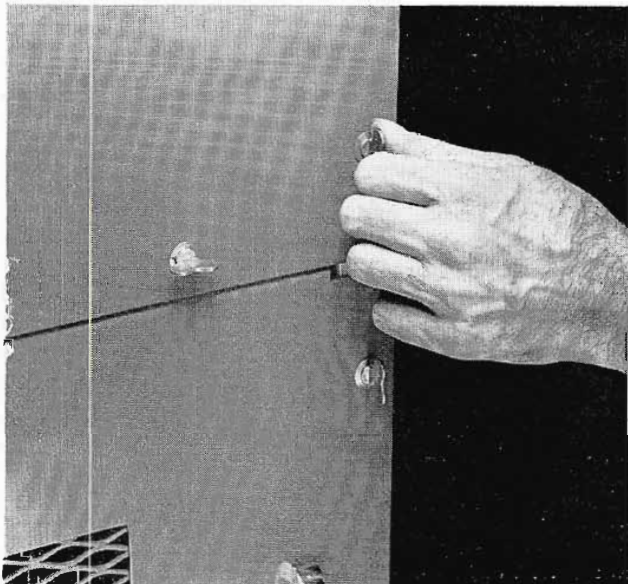
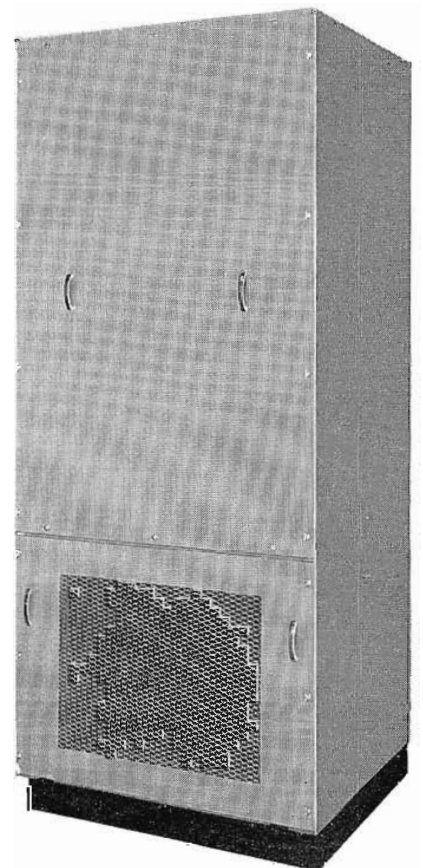

FIG. 3. The rear panels on the BTA-500R and 1R are easily removed with these thumbscrew fasteners to permit speedy access to all chassis.

FIG. 4. Rear view of the BTA-500R and 1R. Note the easily removable panels. An air filter is mounted behind the grillwork on the lower panel, and by keeping dust out of the transmitter maintenance can be reduced.



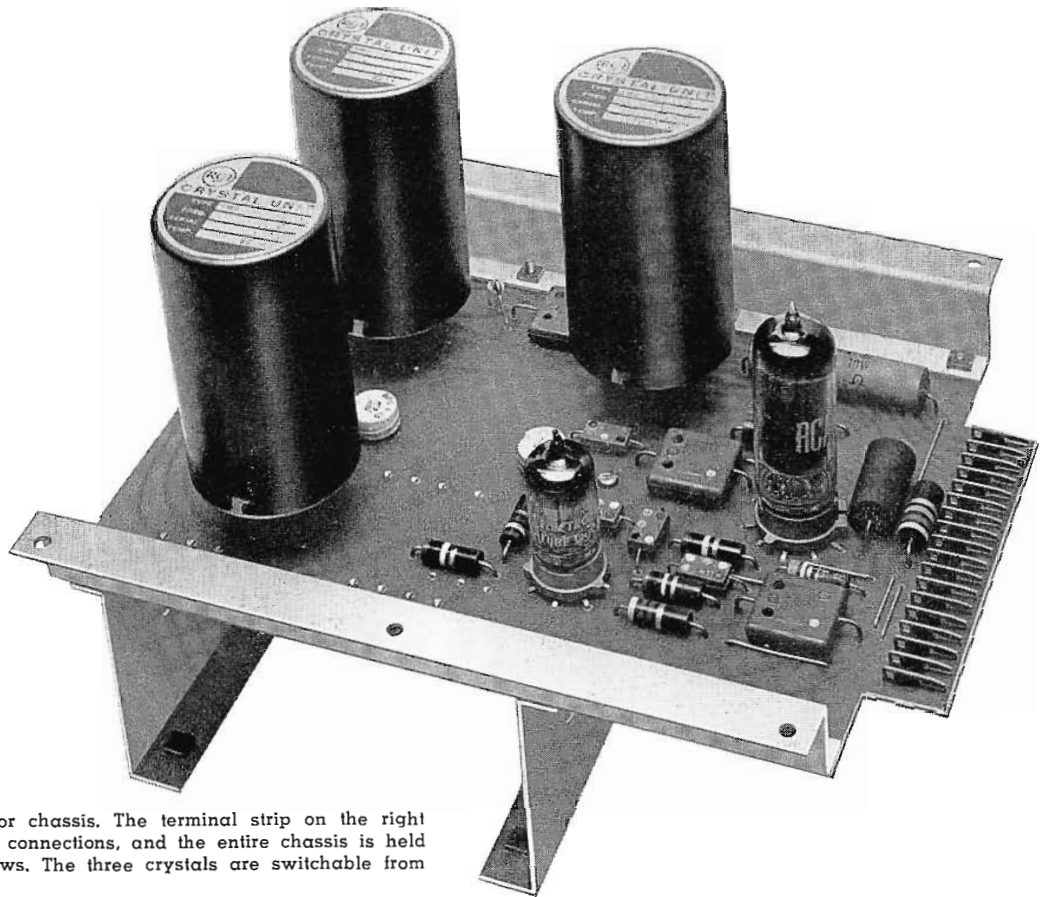

FIG. 5. This is the oscillator chassis. The terminal strip on the right contains all of the oscillator connections, and the entire chassis is held in place with six thumbscrews. The three crystals are switchable from a front panel control.

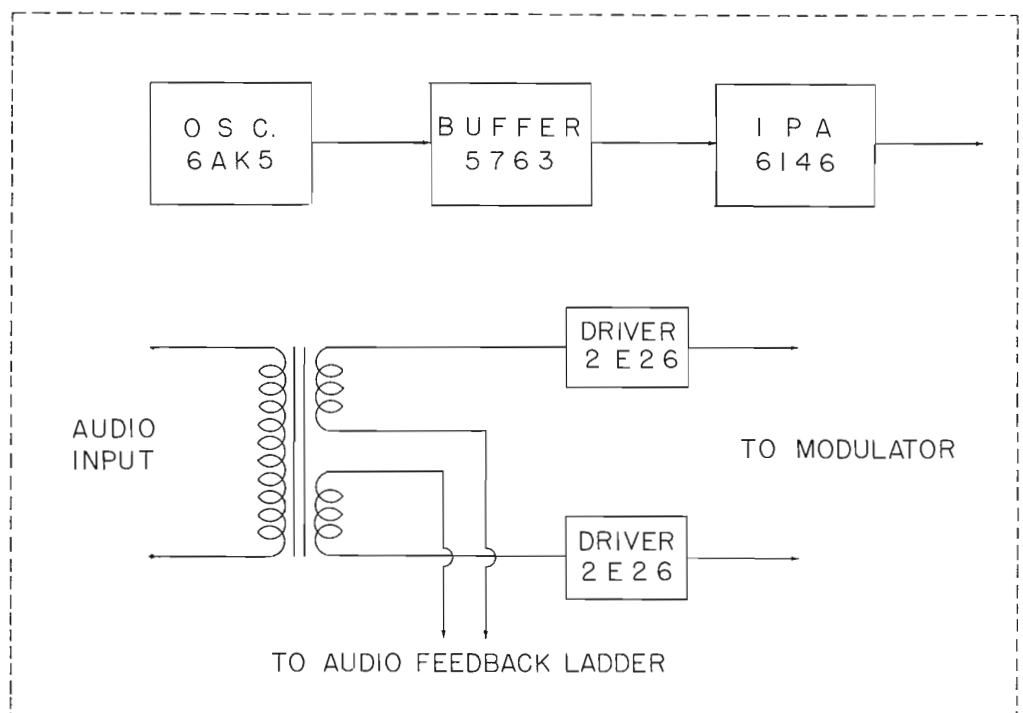

FIG. 6. The basic exciter subassembly is shown in this block diagram. Only three RF tubes are used, and the modulator input uses two tubes.

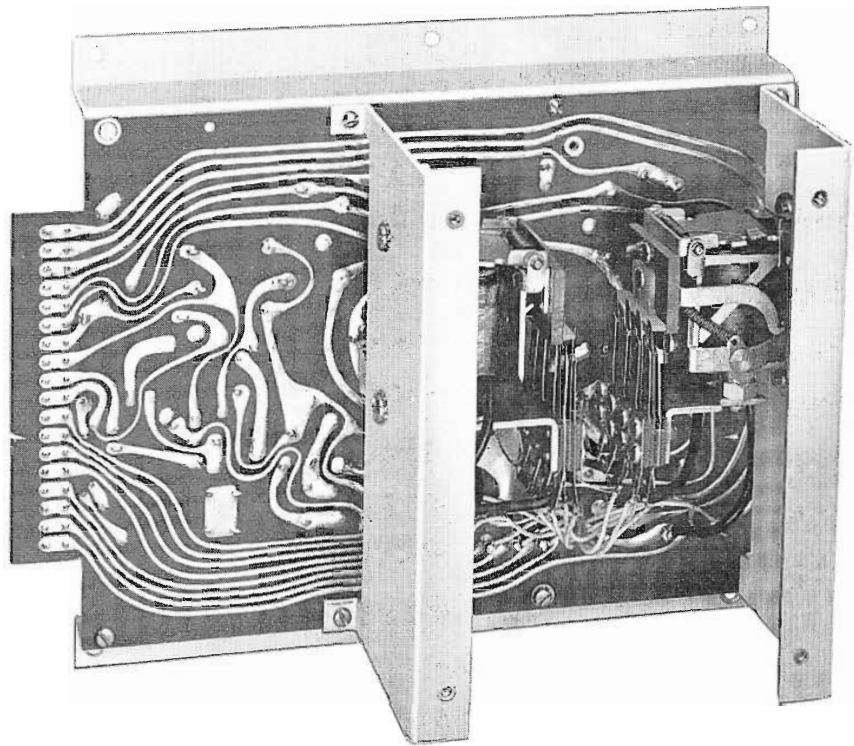

FIG. 7. The underside of the oscillator chassis is shown here. The relays are used to switch the crystals. Etched wiring simplifies servicing and also helps to improve oscillator stability.

### Electrical Advantages

As was previously mentioned, both the BTA-500R and the BTA-1R have been designed around standardized circuits. These circuits have been incorporated in the basic transmitter unit, and it is used in the production of either transmitter. Included in the basic transmitter is an exciter unit, low-voltage/bias supply and a portion of the control circuits. By adding to the exciter unit the proper RF, modulator units, high-voltage rectifier and power-determining components, a BTA-500R or BTA-1R transmitter can be supplied.

### Unique Exciter

The exciter nucleus of the basic transmitter combines in one unit the oscillator, low-level audio and RF stages. This new standardized exciter contains a new type of oscillator, developed by RCA engineers (see Figs. 5 and 6). Three switchable, temperature-controlled, crystal units make up the oscillator. Any of the crystal units will remain constant within  $\pm 5$  cycles. Any of three crystals can be selected by means of a front panel switch, or by means of relays built into the transmitter for remote-control operation. The use of three crystal units provides a spare on the main channel, as well as provisions for automatic Conelrad switching. This new oscillator and buffer incorporate broadband circuits that require no adjustment. A 6AK5 is used as oscillator tube with a 5763 as the buffer. This unit is built on an etched circuit panel (see Fig. 7), easily accessible for service by simply removing the connecting plug and retaining screws (see Fig. 8). Also a part of the basic exciter is the 6146 IPA stage, which is operated very conservatively, and a pair of 2E26 tubes are used for modulator input.

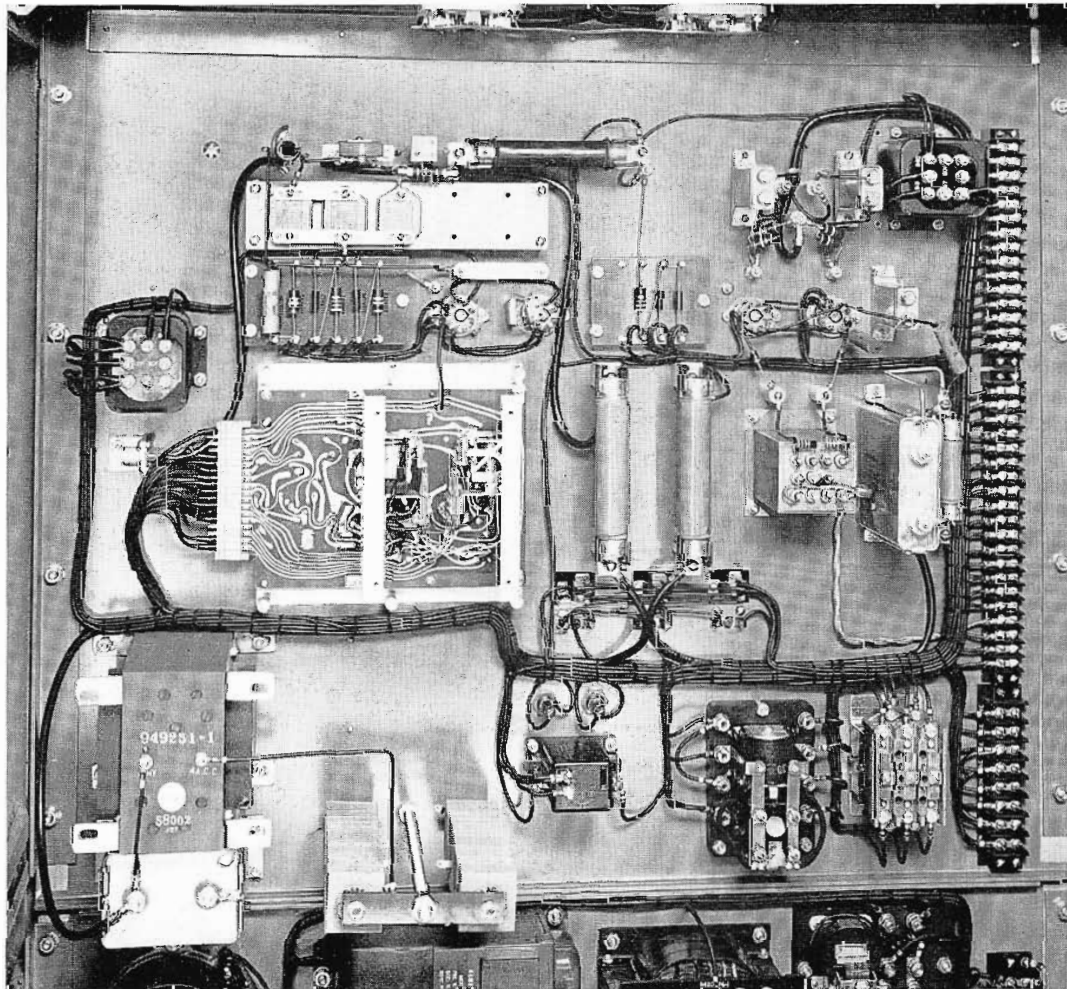

FIG. 8. The entire oscillator subassembly is shown from the rear. Vertical construction provides ease of maintenance. The oscillator chassis is easily removed with six thumbscrews. Note the convenient plug-in terminal strip on the oscillator chassis.

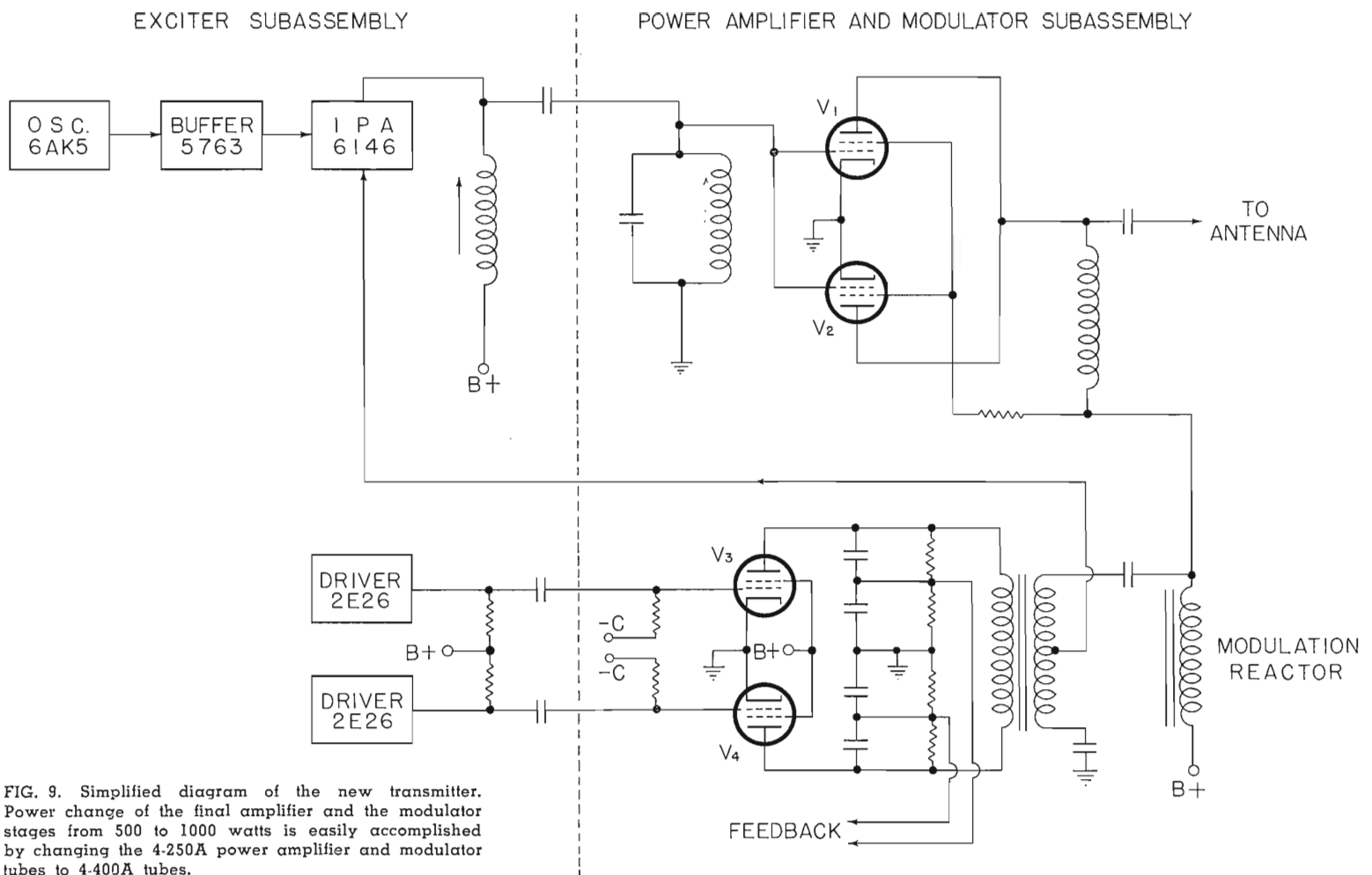

FIG. 9. Simplified diagram of the new transmitter. Power change of the final amplifier and the modulator stages from 500 to 1000 watts is easily accomplished by changing the 4-250A power amplifier and modulator tubes to 4-400A tubes.

#### BTA-500R Circuit

From the exciter subassembly we connect to the next subassembly which consists of the power amplifier and modulator tubes (see Fig. 9). Each subassembly is a complete unit with terminal board terminations for ease of installation. The BTA-500R power amplifier consists of two Type 4-250A tubes connected in parallel, fed by the 6146 IPA from the exciter subassembly. From the same exciter subassembly the two 2E26 tubes in push-pull are resistance coupled to the two 4-250A modulator tubes.

#### BTA-1R Circuit

Again the basic exciter is used, but by adding a different power amplifier and modulator tubes the BTA-1R transmitter is produced. A pair of 4-400A tubes con-

nected in parallel are used for the final amplifier, with another pair of 4-400A tubes for the modulator. As with the BTA-500R, an IPA 6146 drives the r-f power amplifier and a pair of 2E26 tubes drives the modulator tubes (see Fig. 9).

#### Power Supply Features

The low-voltage, power supply used with both these transmitters utilizes selenium dry-disc rectifiers for the plate, screen, and bias. Lower power drain and cooler operation are the reasons for using this type of rectifier for the low-power stages. The high-voltage supply for the power amplifier and modulator plate circuit is built around a pair of 8008 tubes. Their reliability and performance dictate their choice in this application (see Fig. 10).

**Noteworthy Design**

The design philosophy behind these transmitters is based on years of experience in building the most reliable of broadcast transmitters. Simplified tuning, reduced installation time, and provisions for remote control are only a few of the outstanding benefits of these two new transmitters. Tetrodes are used throughout to eliminate the need for neutralization, and improved soundability results from using Bi-Level Modulation. Choice of red, green, blue, and dark umber gray doors add a distinctive touch that, combined with functional styling, permit these transmitters to lend themselves to the decor of a station. Altogether, these unusual features add up to produce many major benefits such as: outstanding performance; provision for remote control; ease and economy of operation and color styling.

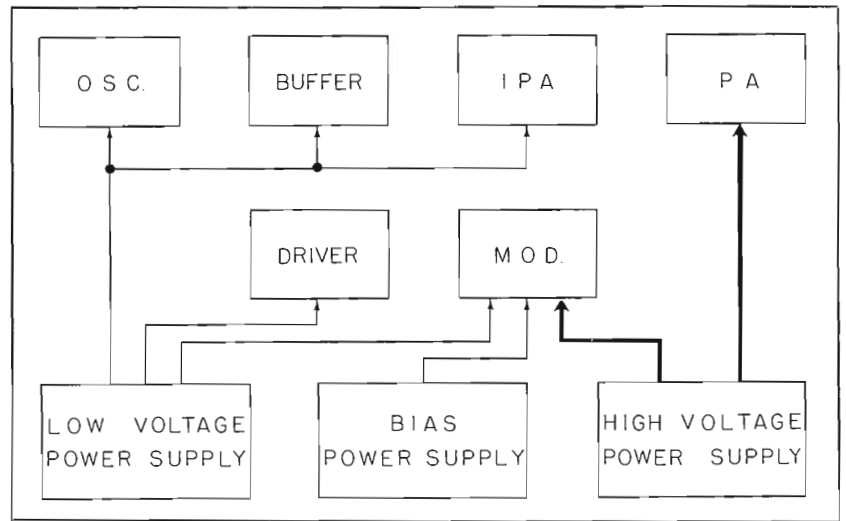

FIG. 10. This block diagram shows the power supplies. The low voltage and bias power supplies use selenium dry-disc rectifiers, while the high voltage supply uses two.

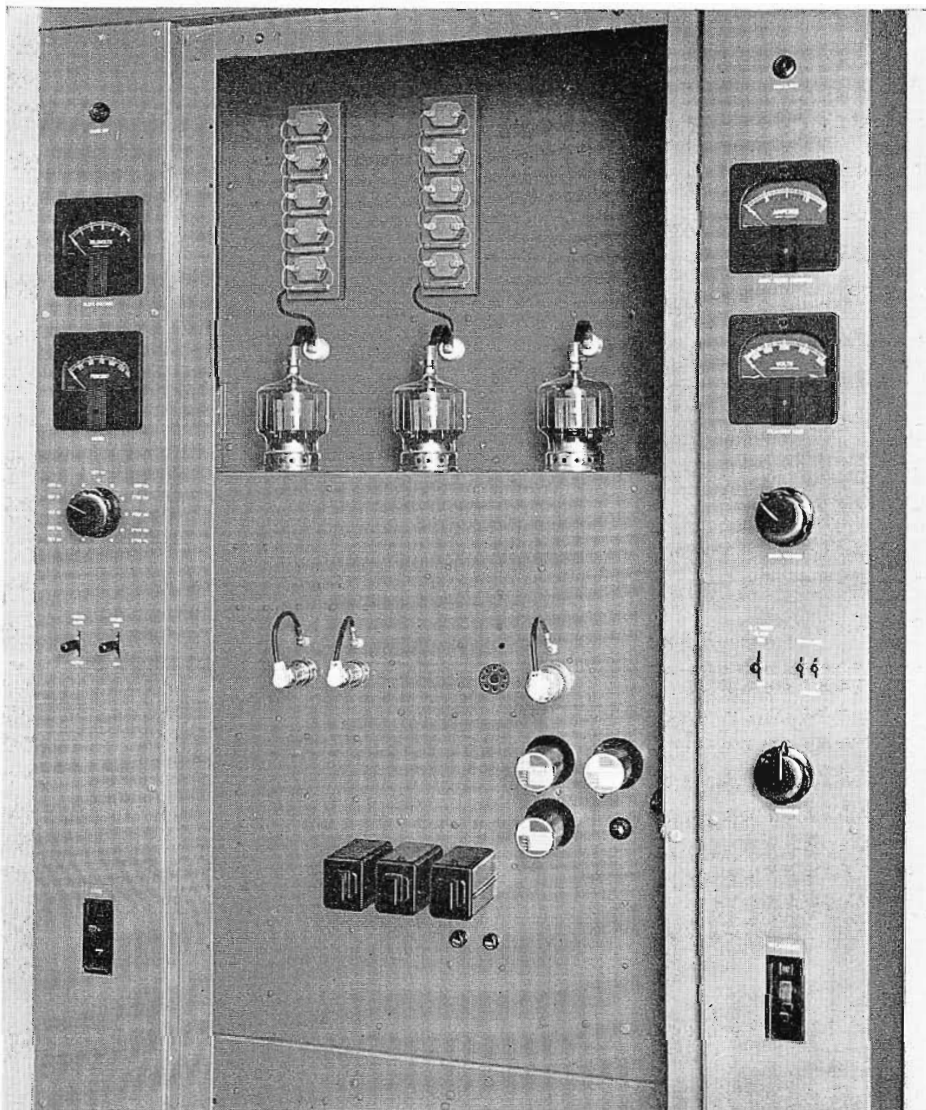

FIG. 11. Front of BTA-500 new transmitter permits easy tube change. Power amplifier and modulator tubes are located on the top chassis, and just below this is the exciter chassis. All normal operating controls are shown on the two side panels.

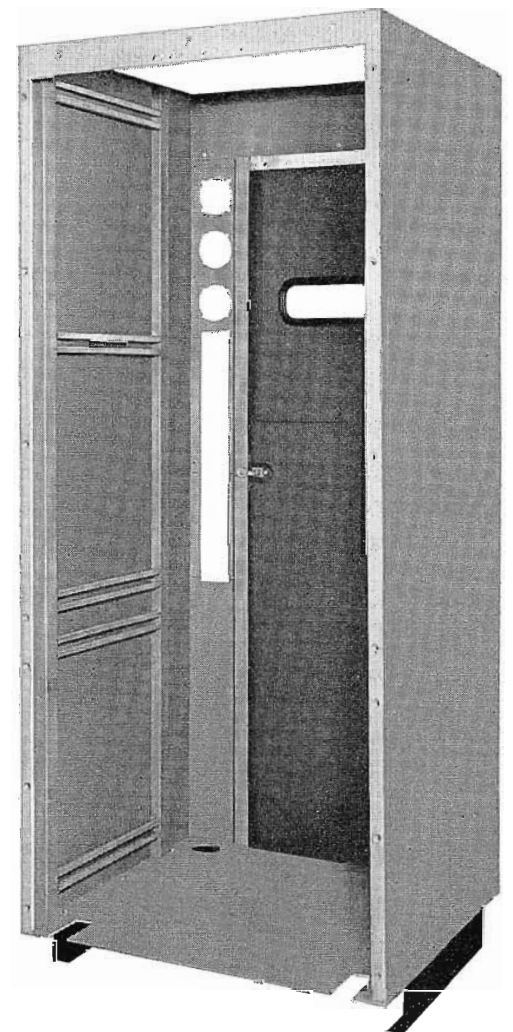

FIG. 12. The transmitter cabinet is made of aluminized-steel for better shielding and strength. The rigid construction is shown here; note the additional supports across the side of the cabinet.

# **K B K C**

## **REVEALS ITS MODERN APPROACH TO RADIO BROADCASTING**

***Pick a Growing Market, Program to Its Tastes,  
and Provide a High-Quality Technical Installation***

by **TOM E. BEAL**, *President and General Manager*

and **ROY D. STANLEY**, *Station Manager and Technical Director*

*Station KBKC, Kansas City*



This is our recipe for success in the radio business: First, we carefully researched and selected our market. Next, we designed a program format to appeal to the intelligent, adult segment of today's huge buying market. Finally, we made no compromises insofar as technical equipment was concerned, because we were interested in getting complete coverage and a high-fidelity signal. And, this approach is paying off.

### **The Market**

We selected the fast-growing metropolitan Kansas City area as our market—especially Johnson County. This county is reported to have the largest average income in the U.S.A.—\$7291. It has a population of 120,000, but no newspaper and no radio station. Many cities are located in sprawling Johnson County, for example, the northeast area in itself has 16 cities. Furthermore, it's a prosperous market, probably one of the fastest growing suburban areas in the country. There are many large shopping centers, giving concrete evidence to the demands of the residents. Here, we decided, is the place to locate our radio station.

### **Contemporary Programming**

Our program format is a contemporary one—aimed at this unique local market. It's tailored to the tastes of our markets, and it's designed to have an individual flavor all its own—somewhat like the NBC concept of "Monitor."



FIG. 1. KBKC building entrance, with lobby on the first floor and studios on the second.

The daily format is built around one main program. This daily program is called "The Day of the Week" and runs from 5:50 a.m. until sign-off. Friday, Saturday and Sunday are known as "Weekend." A carefully chosen music format with well-balanced themes is used to produce daily programming that consistently receives good comment. In fact, the advertising agencies are tying this in with their accounts. Newscasts consist of two daily ten-minute segments: "Morning News Desk" from 7:20 to 7:30 a.m. and "Evening News Desk" from 5:20 to 5:30 p.m. (when sundown schedule permits). In addition, each hour there is five minutes of news, twenty-five minutes after the hour—a time when no other station has news (KBKC has music while other stations have news). Introducing and pointing up this hourly five-minute newscast is a piano keyboard selection—a few minutes prior to the news. After each newscast, KBKC features five minutes of uninterrupted music called "Monday Music," "Tuesday Music," etc., or "Weekend Music."

Furthermore, we plan, directly before each hour, there will be a two-minute

"News Highlights" featuring local and national news. These two-minute specials are to be done via mobile unit and telephone beeper. It may be a hot news report, the local Red Cross drive, the Community Appeal or any other local event that represents a public service. No more than two minutes is to be used for each.

Sponsorship of the newscasts is rotated in order to give all advertisers an even break. Provision is also made for "hitch-hike" of one sponsor's commercial on that of another in these newscast announcements. Sponsorship of KBKC "Hourly News" has been so attractive to advertisers that it has produced 30 per cent of our station revenue, during the second month of operation.

#### Music Format

We offer an adult approach to music programming that is refreshing, we believe, as one considers the usual concepts of music selection. There is no block programming at KBKC—the music is interwoven throughout the entire broadcasting day . . . music that includes big bands, ballads, mood, contemporary jazz, musical comedy hits and the good current hit tunes.

#### Typical One Hour Music Format

- On the Hour:** Band (Instrumental)  
Ballad  
Mood (Instrumental)  
Pop  
Band (Instrumental)  
Ballad  
Jazz (Instrumental)
- On the Half Hour:** Hourly News (5 minutes)  
Band (Instrumental—five minutes of uninterrupted music)  
1. Latin American  
2. Mood  
3. Piano Rhythm  
Band (Instrumental or bright piano jazz)  
Ballad  
Mood (Instrumental)  
Pop  
Band (Instrumental)  
Ballad  
Mood (Instrumental)

We have one show tune per hour at a varied time. We never have vocals back-to-back, but always separate them with instrumental selections.



FIG. 2. Common reception room which KBKC shares with another tenant in the building. Left: Tom E. Beal, Pres.-Gen. Mgr., KBKC.

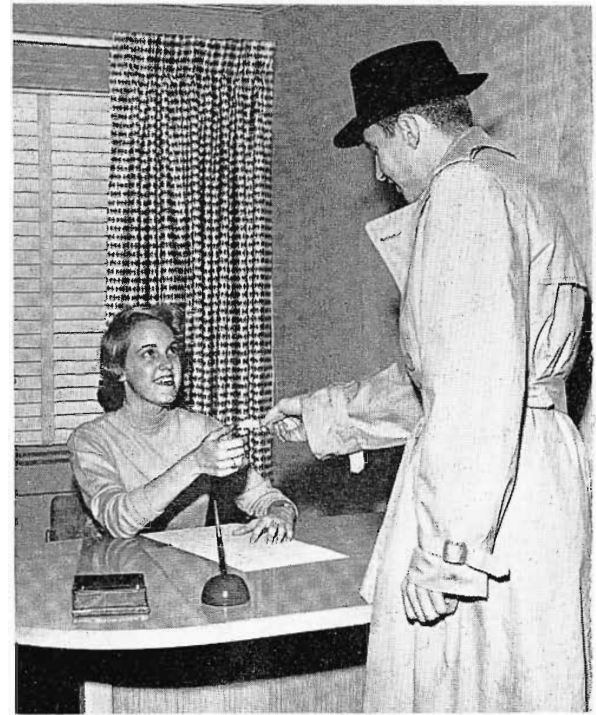

FIG. 3. Offices and studios are on second floor. Shown is Margaret Ann Shaw, Traffic Manager.

### Promotion

At the outset we are "buying our audience" in a way of speaking. By this we mean that contests and prizes designed to stir local interest are costing us a considerable outlay. For example, we are offering two fully paid, round-trip tours to Europe as prizes.

Of course, we are getting a great deal of free promotion also. Local pride is being tremendously stimulated. KBKC is the first radio station in Johnson County. Jaycees and local dealers are putting our promo-

tional streamers in their windows everywhere. And since it's the first new radio station in Kansas City in five years, it is news and something to be talked about. The Jaycees held a parade with queen cars, balloons and all the color of a Mardi gras during the first broadcast day of KBKC.

Another promotional item which we designed is a metal plate, the size of an automobile license plate, for use on cars of staff, stockholders and sponsors. Our call letters are silk screened on this plate

in color. It makes a durable and lasting promotion piece that goes everywhere that we and our customers go. We have also reproduced this plate on cardboard stock. This is to be used on remotes for identification purposes. We can afford to spread these around liberally.

Furthermore, we have created an all-metal highway sign with our station call letters on it. The support consists of a piece of angle iron, seven feet high, pointed at one end and sprayed with aluminum paint. The sign itself is a 12 by 30-inch, silk-screened, metal plate. This is small enough to get by without restrictions but large enough to be identified as one drives by. It is especially designed for use on fence lines.

### Studios and Offices

Centrally located, KBKC studios and offices are in the Dickinson Building in Mission, Kansas. This two-story building is jointly occupied by Dickinson Theatres and KBKC. A common reception room is enjoyed by both on the first floor. In addition, KBKC has its own reception area in a second-floor suite of rooms.

Newsroom, traffic, continuity, office, combination studio-control room and production studio are all housed on the second floor. In addition, KBKC has use of a 52-seat, private theatre on the first floor. Here it is planned to hold sales clinics.

KBKC plans to help its advertisers to merchandise in the most effective ways. There will be clinics for various businessmen: One for auto dealers, another for appliance retailers, etc. Subjects will be "How to Sell," "How to Advertise," "How to Create Traffic in the Store."



FIG. 4. The sales office. Left to right: Tom Mannion and Ron Douglas, Account Executives; Edith Sacco, Continuity Director.





FIG. 5. Linda Lewi, Director of Women's Activities, and Tom Beal in second-floor hallway.



FIG. 6. Studio "A" (control room). Seated is Ben Weaver, Communicator (d.j.). Note the convenience this setup affords.

### Studio A

The main studio is equipped with professional equipment but exhibits the decor of a den or recreation room rather than a work area. Not by accident has this been occasioned. Our station management believes in creating a homelike atmosphere for the enjoyment of the staff.

No equipment racks are seen in the studio—all are built in. Wall-to-wall carpeting covers the entire floor area. Record storage and parts storage are in completely enclosed areas. Furnishings are not bulky but of attractive modern design, fitting well into this 13 by 17-foot studio.

Even the control console and turntables are part of the unusual design. For the operator's convenience, the equipment is arranged in a "U"-shaped pattern. The console is directly in front of him, with turntables on the right-hand side and tape players on the left.

The control console, Type BC-3B, is mounted on a free-shape table. Three BQ-2B turntables are built into an attractive cabinet. This provides a convenient in-line arrangement for the operator. Three preamplifiers, the BA-25 Automatic Gain Control, the cue and speaker are all accommodated within the custom-built turntable cabinet. (These equipments can be easily serviced from the rear of the cabinets.) Two portable tape recorder players, Type 601, are mounted on a record cabinet. Above the control console hangs a 77D microphone supported by a Dazor type mounting. The turntables and tape recorders are operated by remote control with finger-tip switches mounted on the console table. We custom-built our studio installation this way and designed it ourselves for economy and for ease of operation.



FIG. 7. Jerry Fullerton, Communicator, doing a beeper report through console of Studio "A."



FIG. 8. Studio "A" (control room) is equipped with BC-3B console. Note two tape recorders on left, and three built in BQ-2B turntables at right.



FIG. 9. Studio "B" (production studio) is being used to produce commercials and special programs. Left: Marvin Bredemier, Engineer, using Type BN-6A, 4-Channel Remote Amplifier. Right: Chuck Goodman, Newsmen, recording special news features. The equipment is portable and can be taken out of the studio for special remote broadcasts, setup for any type.

**Production Studio (B)**

Adjoining Studio A is a room 12 by 17 feet, designed for production purposes. It serves for making tapes in advance, for preparing spot announcements, and for readying live shows. Thus it constitutes an auxiliary to the main studio, and is equipped with a small control console, two turntables and tape recorder in order to carry on a completely independent operation, when required.

A modernistic styled control console is employed in Studio B. The consolette and turntables plus monitor and tape machines are entirely portable. Thus, they may be moved to remote broadcast locations in a very short time, providing a complete studio wherever needed.

**News Center**

Just a few feet away from the production studio is an irregularly shaped area approximately 10 by 14 feet which serves as the news center. Here is the AP teletype machine and the office of the newscaster on duty. Equipment includes Type 77DX Microphone, and monitor for police and fire frequencies. (Plans are now in process for a two-way radio unit for contact with our proposed mobile unit.) Facilities are also here for telephone beeper recording.

**Station Staff**

Our initial staff consists of the following nineteen persons:

- General Manager
- (and Acting Commercial Manager) . . . 1
- Station Manager
- (and Acting Tech. Director) . . . . . 1
- Program Director . . . . . 1
- Chief Engineer . . . . . 1
- Transmitter Engineers . . . . . 2
- Salesmen (Account Executives) . . . . . 4
- Traffic-Receptionist . . . . . 1
- Continuity Director . . . . . 1
- News Director . . . . . 1
- Assistant Newsmen . . . . . 1
- Women's Activities Director
- and Music Librarian . . . . . 1
- Sports Director . . . . . 1
- Announcers—DJs (Communicators) . . . 3

We like to think of our announcers as *communicators*—talking *with* the people, not *to* the people. They are high level men, sharp and quick of mind, but also personable and communicative. The kind who take people places and who do things. The kind that strike immediate response in the adult mind.

We also have one inflexible rule: "No talk to last over two minutes." This, we believe, provides a modern, fast-moving pace. It is one of the essential ingredients of our radio format.



FIG. 10. Studio "B" (production studio) showing program director's desk to the left and control center to the right.

FIG. 11. Ron Douglas, Newscaster, at work in KBKC news center.



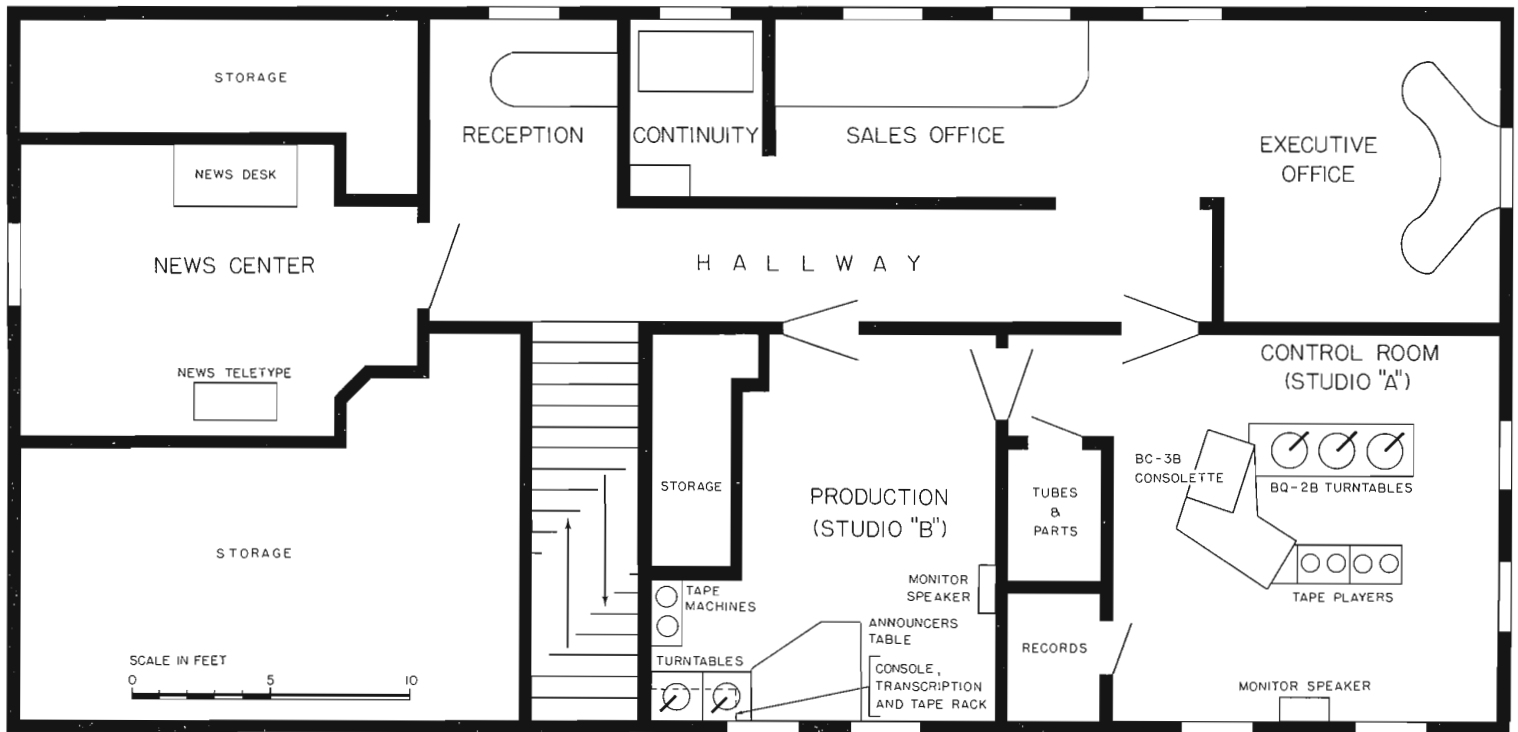

FIG. 12. Floor plan showing all KBKC offices and studios, located on second floor of building. Large common reception room and lobby is on first floor.

### Transmitter Installation

The transmitter is located approximately six miles ( $4\frac{1}{2}$  miles airline) from the studio. Since it is eventually to be remotely controlled from the studio, no personnel will be required at the transmitter. This means a very small building (see Fig. 13) with no need to install septic tank, water connections, etc. (Until the first year of operation is concluded, in accordance with FCC requirements, an operator must be retained at the transmitter.) For this situation, temporary facilities are made available but, at the end of the year, the transmitter operator will become our studio engineer.

A 500-watt RCA Transmitter, Type BTA-500MX is employed. The antenna system is a three-tower directional array, designed to cover the metropolitan Kansas City area. Towers are 185 feet high, insulated guyed affairs. Transmission lines, power lines and telephone cables are all buried.

Phasing equipment was custom-built by RCA. Instrumentation and radiation of our array have proved to be very stable. There is practically no need for adjustment. Part of this stability is due to design: part by the buried lines.

Three pair of wire lines are run by the local telephone company to the transmitter. One pair is a Class "A" 15,000 cycle audio line for program purposes. Two pair are dc lines for use with the remote-control



FIG. 13. Transmitter building showing center tower in rear. Note compactness of building and inexpensive type of construction which is typical for remote operation.

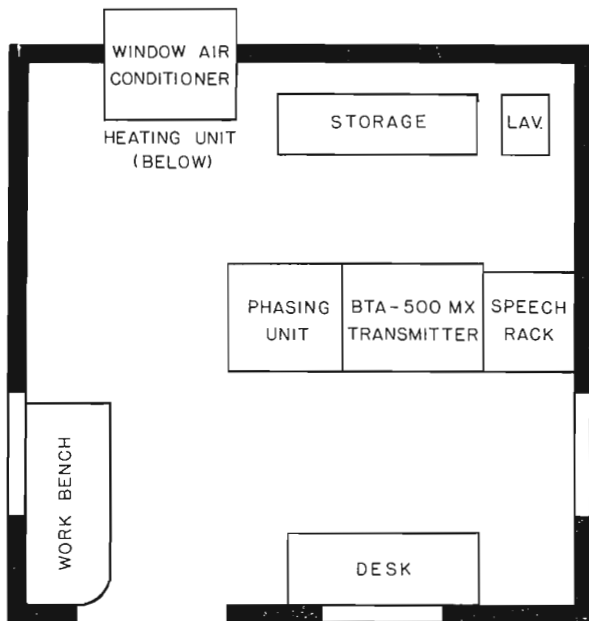

FIG. 14. Layout of KBKC transmitter building showing all facilities required for remote operation.

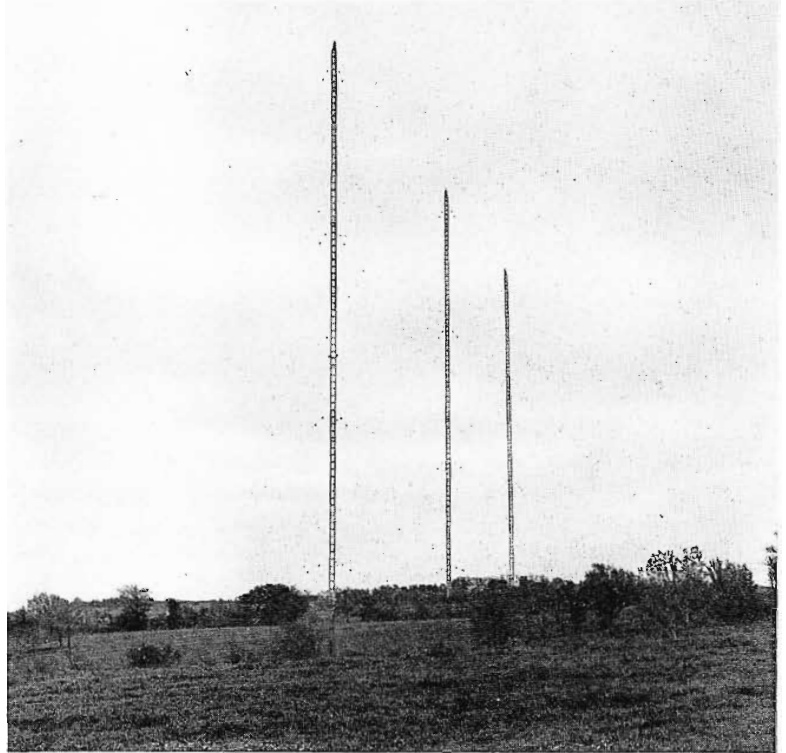

FIG. 15. Three-tower directional antenna system designed to cover Kansas City area. Towers are 185-ft. high, insulated guyed affairs.



FIG. 16. View inside transmitter building showing engineer tuning speech rack (No. 3 rack). Cabinet No. 1 (extreme left) contains phasing equipment. Cabinet No. 2 is the BTA-500MX.

unit. In addition, there is a telephone line for continuous communication purposes.

Station management foresaw the advent of remote control, placed a contingent order for equipment and when FCC legalized this type of operation, KBKC was among the very first to further its plans. It is this type of operation that is very efficient in providing effective coverage of large area with low power. Further, the economy of unattended operation often makes the difference between operating in the *red* and operating at a *profit*.

#### Essential Investments

Good money is being paid for staff and equipment—higher than usual for a station of its class. This is justified on the basis that what people hear is important. This is the identity of our station. We believe it constitutes a good business investment. We aim to be a first-class station with first-class accounts, and to do this we have acquired first-class equipment.

We deliberately planned to start on the top level. It is easier to start there than to try to get there later. All our plans are made on that basis. Therefore, from the outset, everything is of high quality—personnel, programming, advertising and technical equipment.

#### Transmitting Equipment

There are three racks in the transmitter building (see Fig. 16). Rack No. 1 contains the custom built phasing equipment. Rack No. 2 contains Type BTA-500MX Transmitter. Rack No. 3 contains equipment as follows (from top down):

- a. Limiter Amplifier
- b. BW-66E Modulation Monitor
- c. 108E Phase Monitor
- d. BW-11A Frequency Monitor
- e. Monitor Speaker

On the top of Rack No. 3 is a Conelrad receiver. The transmitter building is electrically heated and cooled for efficient equipment operation and comfort of engineers on duty.

### Inception of KBKC

The idea was born in our minds while working for a radio station in Kansas. We foresaw the future possibilities for a station in this 18th market of the U. S. which had only eight stations. There are markets of much smaller size which have as many as 14 stations. And this example could be multiplied by many more. But Kansas City has not had a new radio station for many years. Since radio is making a highly successful resurgence elsewhere, why not in Kansas? The idea grew apace and we had the necessary study made in Washington by a consultant, then papers were prepared and filed before the FCC. Within a short time, we obtained the CP (construction permit) for a new station and, in October 1957, the idea became a reality! Now, KBKC is an ideal suburban radio station having nice relations with local merchants.

### Business Outlook

Because of the advance promotion and selling before going on the air, KBKC started broadcasting October 26, 1957, with considerable business. During the first month of operation, the station operated in the black. This is a real success story.

Our station went on the air with a total of 32 accounts. We had four accounts signed for a total of 2000 one-minute spot announcements a year; six with 1200 spots; and eight with 600 spots a year, while the rest of the accounts varied. We had six of the daily newscasts sold on a 13-week basis before going on the air.

Business is far greater than we had ever expected. Effective March 1, 1958, we will have as our national representative, The George P. Hollingberry Company.

### Future Plans

Foremost on the list of things to be done is the acquisition of a mobile unit for remote pickup. It is envisioned that this shall be a station wagon equipped for on-the-scene news reporting. Equipment will include tape recorders and two-way radio. Thus, programs can originate live from the mobile unit.



FIG. 17. Executive office of KBKC. Left: Roy D. Stanley, Station Manager and Technical Director. Right: Tom E. Beal, President and Gen. Manager.

Next, we are presently applying to FCC for an increase of power from 500 to 1000 watts. All phasing equipment and the transmission line were designed for 1 KW operation. The transmitter is easily converted from 500 to 1000-watt output, having facilities of power increase built-in with only a power conversion kit needed for the 1 KW conversion.

The third step in station expansion will be conversion to nighttime operation. For this it will be necessary to install two additional towers, giving the necessary 5-tower array to produce the required pattern. Again provision for this was made at the outset. Sufficient ground was acquired for the 5-tower installation and sufficient space was allowed in the transmitter building to accommodate an additional phase unit so that nighttime conversion could be conveniently installed.

In addition, it is eventually planned to install auxiliary power generating equipment at the transmitter building, since the suburban area where the transmitter is located is more subject to commercial power failure than a central city location. When all these future plans are consummated, we feel that KBKC radio will become not only a fine business proposition but an excellent asset to the metropolitan area of Greater Kansas City.

FIG. 18. John Herrington, KBKC News Director, displaying a metal highway sign used for station promotion.

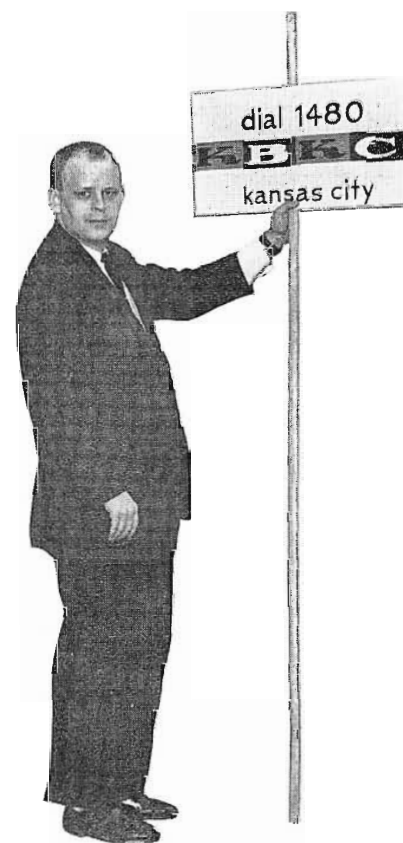

## HOW TO DESIGN THE ANNOUNCE BOOTH TO GIVE

by JOHN F. PALMQUIST, *Broadcast Field Sales*

Many present day radio control rooms are not only used for this purpose, but also act as announce booths where most of a station's announcing is carried on. In many cases the control room may be the only studio area in a station, and it will contain all the station's audio equipment. Frequently, a transmitter and a record library will also be located in the control room. This makes the problem of acoustics more complex but since radio sells with sound, good acoustics are a must when the best sound possible is desired.

### Design Factors

Combination control rooms are at best a compromise of the several design factors. When designing this control room, consideration must be given to the following:

1. Location of the control room within the studio building;
2. Isolation—elimination of unwanted sound and noise, both internal and external;
3. Construction—dual wall, floating wall, single wall;
4. Reverberation control, elimination of unwanted reflections, and floor treatment;
5. Ventilation and air conditioning;
6. Size and arrangement of equipment.

### Location

The combination control room must be located so that it is convenient to the office areas, but traffic in and out of the room should be minimized in order to reduce distractions to the announcer. The location selected must have as little external acoustical and electrical noise as possible. The control room should be located away from street noise, or noise that may be generated in other parts of the building, because it may become difficult and costly to reduce unwanted noise that enters through the floor and walls. Air-conditioning compressors and other rotating machinery should be well isolated and kept as far away from the control room as possible.

It is not wise to locate a control room next to a power transformer vault, or other large electrical equipment that may produce strong electrical fields. These strong electrical fields may cause noise problems in audio equipment. If the control room contains the transmitter, great care should be given to the grounding of all audio equipment including equipment racks, consolettes, turntables, pickup arms, and other metal objects. In some cases, it may be desirable to shield the control room with copper screen to reduce noise generated from high power RF fields of the nearby transmitters and antennas.

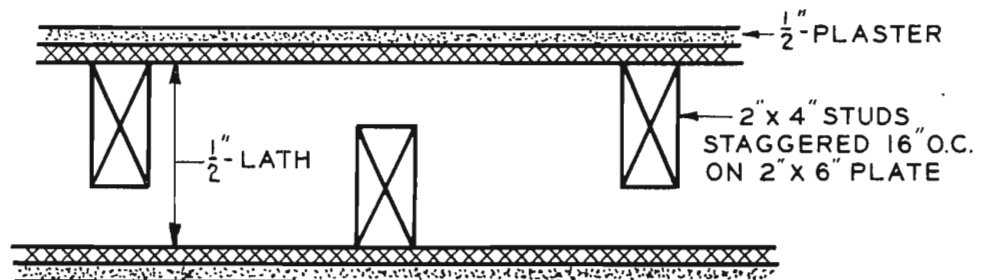

FIG. 1. This shows a cross section of a sound-insulating partition. Wooden walls should be constructed in this manner to reduce external noise.

# COMBINATION CONTROL ROOM - GOOD ACOUSTICAL PERFORMANCE

## Isolation

Ideally, a control room should be a sound-isolated room within a room. Cost considerations in a small station may make such construction impractical, but it should be considered when possible. The floors and walls should be built from materials that will minimize the transfer of sound into the control room. Many new stations use concrete block walls and concrete slab floors, that are isolated from the building walls with asphalt impregnated glass fiber-board. This type floor construction is very practical since it reduces outside vibration in the control room floor.<sup>1</sup> A stable floor will improve turntable operation by reducing vibration that enters the pickup system from external sources.

<sup>1</sup> "Impact Noise Isolation in Television Studios," BROADCAST NEWS, Vol. 97, Oct., 1957.

## Construction

The ideal control room wall would consist either of a dual masonry wall, or a masonry wall with a sound-isolated floating inner wall.<sup>2</sup> In the smaller stations, cost considerations usually preclude this type of construction. A single wall of masonry, cement, gypsum, or pumice block is a good compromise, which is completely satisfactory where external noise is reasonably low.

Wood wall construction should not be used unless double walls are used. Staggered 2 by 4-inch studs can be set on 16-inch centers on a 2 by 6-inch plate for the double wall construction (see Fig. 1). Rock wool bats can be interlaced between the studs for additional sound isolation. There

<sup>2</sup> "Applied Architectural Acoustics," by Michael Rettinger, Chemical Pub. Co., Inc.

should be at least 2 inches of rock wool, or other sound-absorbing material, above the ceiling surface, and if external noise is of large magnitude, the ceiling should be sound isolated.

If care has been given to the location of the control room in a given building, the offices and other quiet areas surrounding the control room may screen it from unwanted sound. Control room doors should be the heavy soundproof type (see Fig. 2), or double doors should be used. Observation windows should be kept to a minimum. Each such window should consist of two panes of heavy plate glass of different thicknesses to break up resonance conditions. The glass plates should be set in rubber or felt gaskets, and usually the glass plates are set about 10 degrees off vertical (see Fig. 3).

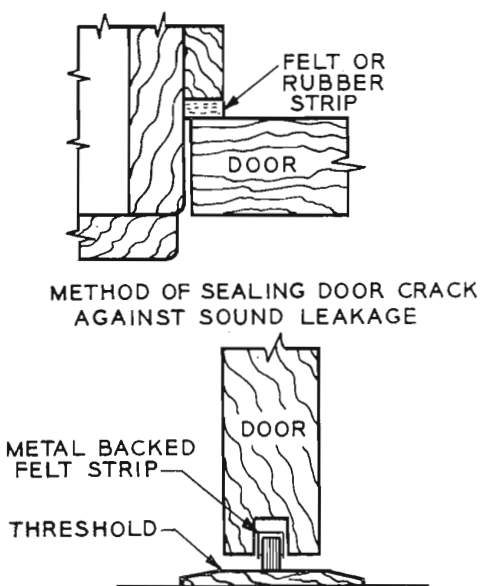

FIG. 2. Here are the normal methods for sealing the control-room door. The door itself should be of the heavy type to improve isolation of the control room.

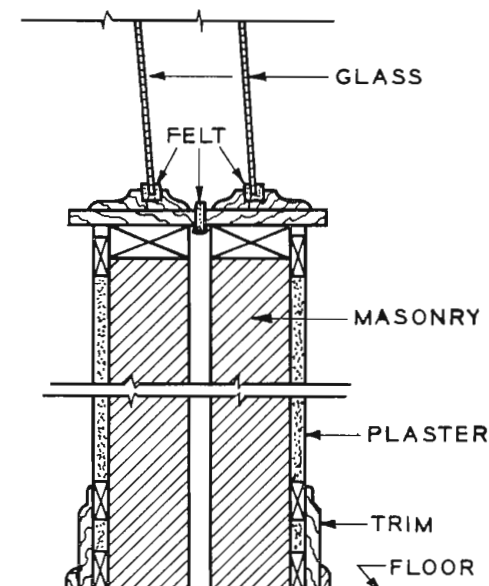

FIG. 3. Sound-insulating window construction showing structural separation of double wall. Glass windows in studios and control rooms should be offset about 10 degrees, and they should be mounted as shown on a double wall.

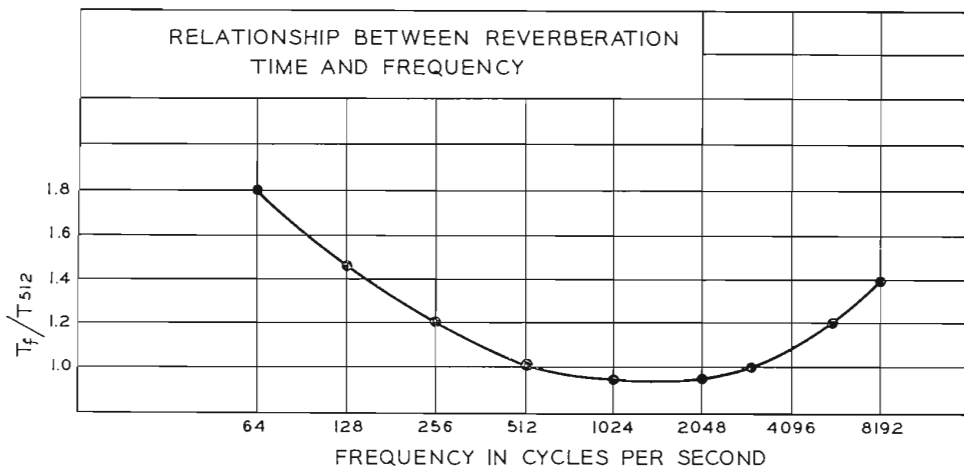

FIG. 4. These Morris-Nixon curves show the relationship between the reverberation time and the frequency. Reverberation time should remain fairly constant between 100 and 5000 cycles.

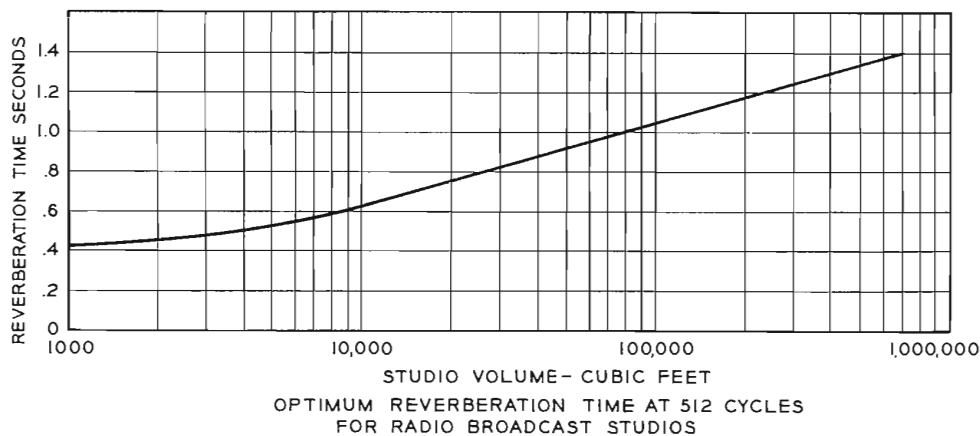

FIG. 5. This curve shows the variation in reverberation time as the size of the room increases with a 512-cycle reference signal.

### Reverberation Control

Some form of reverberation control should be employed within the studio. If a studio has too long a reverberation period, the sound may blur and speech may lack intelligibility. Such sound characteristics are not pleasing to the listener. Generally a studio should have an approximate reverberation time of 0.4 seconds for a volume of 1,000 cubic feet rising to 0.6 seconds for 10,000 cubic feet<sup>3</sup> (see Fig. 5). The reverberation time should be about the same from 100 to 5,000 cycles, but it may rise slightly at 5,000 cycles (see Fig. 4). This type studio characteristic helps eliminate low-frequency boominess.<sup>4</sup> An

<sup>3</sup> "NBC Studio Design," Journal Acous. Soc. AM., Vol. VIII (Page 31, 1936).

<sup>4</sup> "Acoustical Design and Treatment for Speech Broadcast Studios," by Edward J. Content and Lonsdale Green, Jr., Proceedings of the IRE, Vol. 32, No. 2, Feb., 1944.

acoustical consultant should design the studio and supply the proper materials.

Consideration should be given to all wall and equipment surfaces in the control room in order to eliminate unwanted reflections. Perforated hardboard or Transite may be used for wall coverings with rock or glass wool placed behind it for sound absorption (see Fig. 6). Hardboard may be painted, and it is easily maintained with occasional washing. The hardboard may be used for wall panels set at various small angles of 5 to 10 degrees to produce greater diffusion of sound.

All glass surfaces should be set on an angle to reflect sound into ceiling's sound-absorbing surfaces. Glass surface should be kept to a minimum, and large corner areas of glass should be avoided. The floor covering should be of a soft material, such as cork or vinyl tile, to reduce surface noise. A rug may be necessary to produce required deadening in control rooms having many glass surfaces and other reflecting areas. The surface of the operating table should be made of some soft material such as linoleum or vinyl. This will reduce table-top noise.

### Microphone Requirements

A good microphone with proper directional characteristics is important in the control room. A 77-DX microphone operated in a unidirectional pattern is recommended (see Fig. 7). The BK-5A microphone is also an excellent microphone for the control room. The distance between the speaker and the microphone will be determined by the acoustics of the control room; however, good microphone technique is important for all air personnel if natural reproduction is desired.

### Ventilation

To do a good selling job, an announcer must sound alive. It is important to provide air conditioning and ventilation so that announcers have a good environment in which to work. A central air-conditioning system is recommended. The air is brought in through ducts from the coolers. The air ducts should be lined with a sound-absorbing material for a distance at least 20 times the average width of the duct. A separate duct should be run to each studio and to each control room to avoid sound transfer through the ducts. Low-velocity air should be used to prevent air noise from the duct openings.

If the control room contains a transmitter, it is usually possible to exhaust hot transmitter air to the outside, and to cool



the transmitter with spent-room air. If this is not possible, the transmitter should be partitioned off from the control room, and a separate source of air should be used to cool the transmitter. The transmitter may be remotely controlled if it is in another room, some distance from the control operation. Such a procedure may save many dollars in construction costs, and also eliminate a source of noise in the control room.

### Equipment Arrangement

The equipment selected will, to a large extent, determine the physical aspects of the control room. The size of the control room should be adequate enough to contain all required personnel and equipment. At the same time thought should be given to possible future expansion, extra space should be provided with this in mind. A control room that is a little larger than necessary at the outset makes it easily expanded later. Furthermore, it is always more difficult to acoustically treat a small room than a large room.

### Planning it Right

A good architect should be consulted when planning a studio-control room. After a general station plan is formulated and equipment selected, the architect and the consulting engineer should work out the specific construction details for the station. A careful acoustical planning combined with good equipment will enhance the sound of any station, and make its sound sell more.

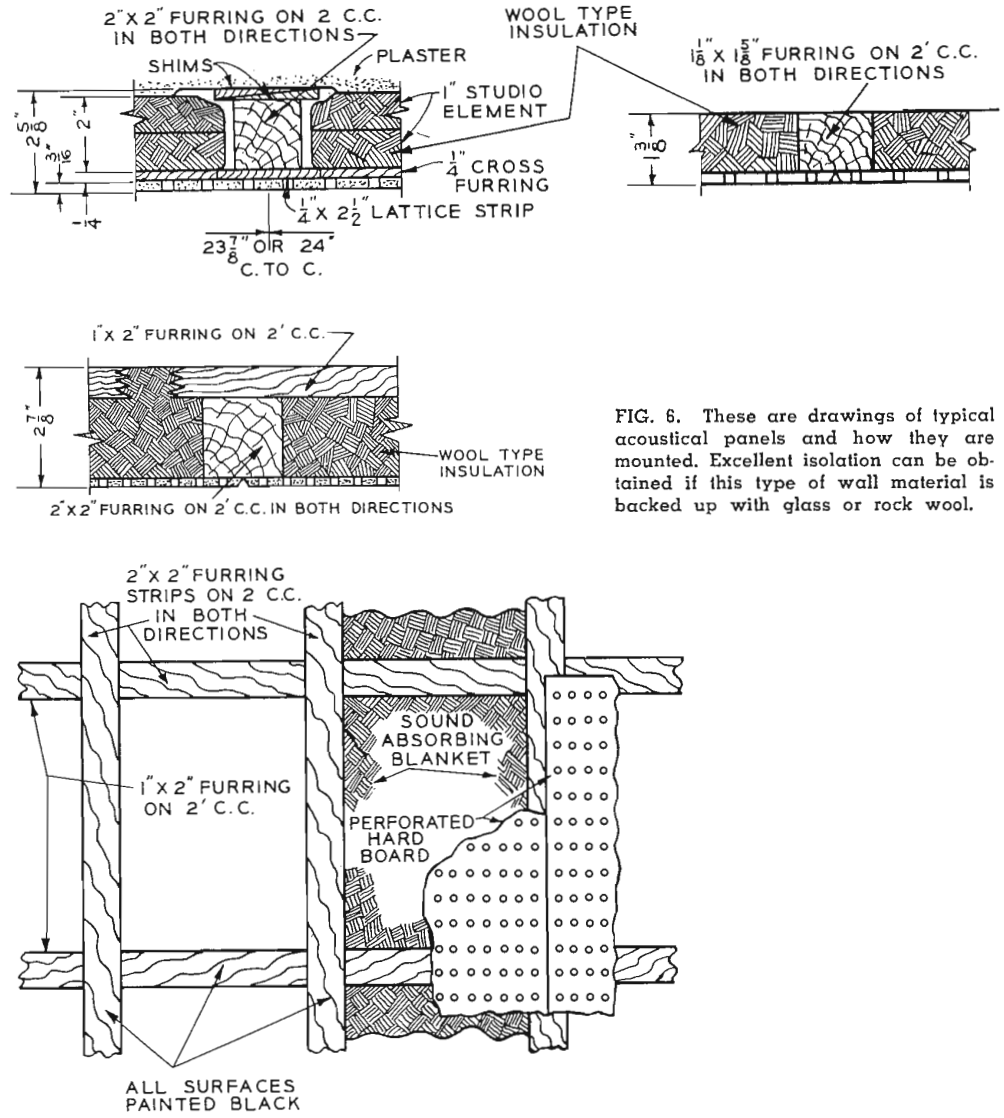

FIG. 6. These are drawings of typical acoustical panels and how they are mounted. Excellent isolation can be obtained if this type of wall material is backed up with glass or rock wool.

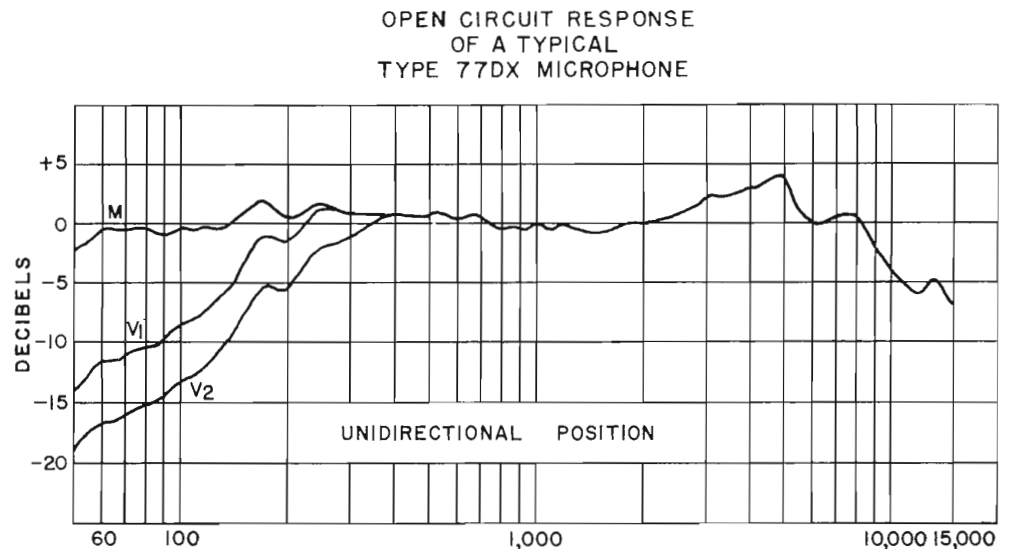
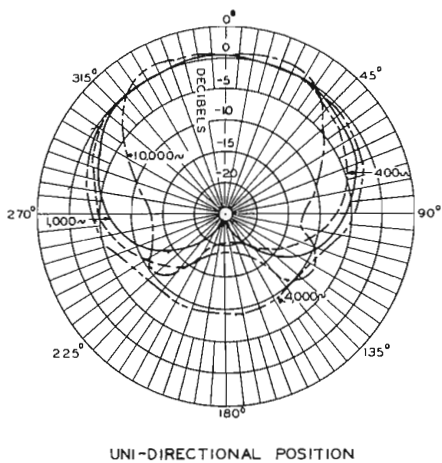

FIG. 7. This is the unidirectional response curve for the RCA Type 77-DX Microphone. A good microphone is necessary for combination control rooms.

# THE NEW BK-10A BIGRADIENT UNIAXIAL MICROPHONE

by J. W. O'NEILL, Industrial Electronic Products, Transducer Design Group

High-quality sound is an important consideration in the broadcast industry, hence microphone selection and design plays an important part. It is not always easy to maintain an atmosphere that is suitable for quality sound pickup, especially considering the added equipment and personnel required for TV. In addition, acoustics of television studios have not kept pace with the visual possibilities except in the recently engineered TV centers. Although the polydirectional microphone and the uniaxial microphone overcome many difficult noise situations, there are circumstances that can render their performance ineffective. The Type BK-10A Bigradient Uniaxial Microphone<sup>1</sup> was specially engineered to supplement the 77-DX and BK-5A in high-noise areas. It features a second order gradient directional characteristic which may be used to increase the signal-to-noise ratio.

## Advantages

The size and weight of the BK-10A are fully compatible with present boom equip-

ment. Shock mounting and a new cable provide excellent isolation from *stand noise*. Low-gloss finish and a compact mounting arrangement provides minimum light reflection and minimum shadow. Field tests have indicated that the BK-10A is ideal for controlling the level of the leading voice in a choral group. It can also be used very effectively when the solo voice is upstage and the choral group is downstage.

Using the BK-10A on the solo voice, it will be found that the downstage choral group is attenuated to a level that permits the use of a separate microphone for the downstage group; thus the levels can be mixed to any desired degree. The BK-10A is also good for picking up weak voices without getting the microphone in camera range.

## Design Features

The second order gradient directional characteristic of the BK-10A is made possible through the electrical combination of the outputs of two mechanically integrated microphone elements. The microphone elements are patterned after the quality per-

formance and rugged construction of the Type BK-5A Uniaxial Microphone.<sup>2</sup> The electrical combination of the outputs of these two axially located microphone elements result in a directional pattern with wide angle forward response, with a null at the sides and rear. The two microphone elements are carefully matched in the manufacturing process to derive the desired response, sensitivity and directional characteristics. The two ribbons are adjusted to have fundamental resonance within two cycles per second of each other. The output of the microphone over the entire rear hemisphere is 12 db less than the output for "on axis" sounds with the nulls providing 18 to 20 db of attenuation. The directional efficiency of this order may be most readily demonstrated with the following comparison. For identical conditions the ratio of signal to random noise or reverberation when a nondirectional microphone is replaced with a cardioid microphone may be increased by 4.75 db. The signal to noise ratio improvement is 8.75 db when it is replaced by the BK-10A.

If the sound source is sufficiently loud the distance from the talent to the microphone may be increased  $1\frac{3}{4}$  times when the nondirectional microphone is replaced with a cardioid type microphone. For the same performance with the BK-10A the distance may be increased  $2\frac{3}{4}$  times the distance required for nondirectional microphones. This feature allows quality reproduction during problem "wide angle" shots in areas of relatively high random noise.

The microphone elements include the RCA designed blast filtering to reduce the possibility of damage caused by gun blasts and other violent noises. The electrical circuits are carefully balanced for hum pickup, and the transformers are exceptionally well shielded to maintain a minimum of stray magnetic field pickup. This careful design reduces the over-all hum pickup to a level of  $-127$  dbm.

The output impedance of the BK-10A is 200 ohms for use with preamplifiers

<sup>1</sup>"Bigradient Uniaxial Microphone," RCA Review, Vol. XVII, No. 4, Dec., 1956.  
<sup>2</sup>"The New BK-5A Uniaxial Microphone," BROADCAST NEWS, Vol. 83, May, 1955.

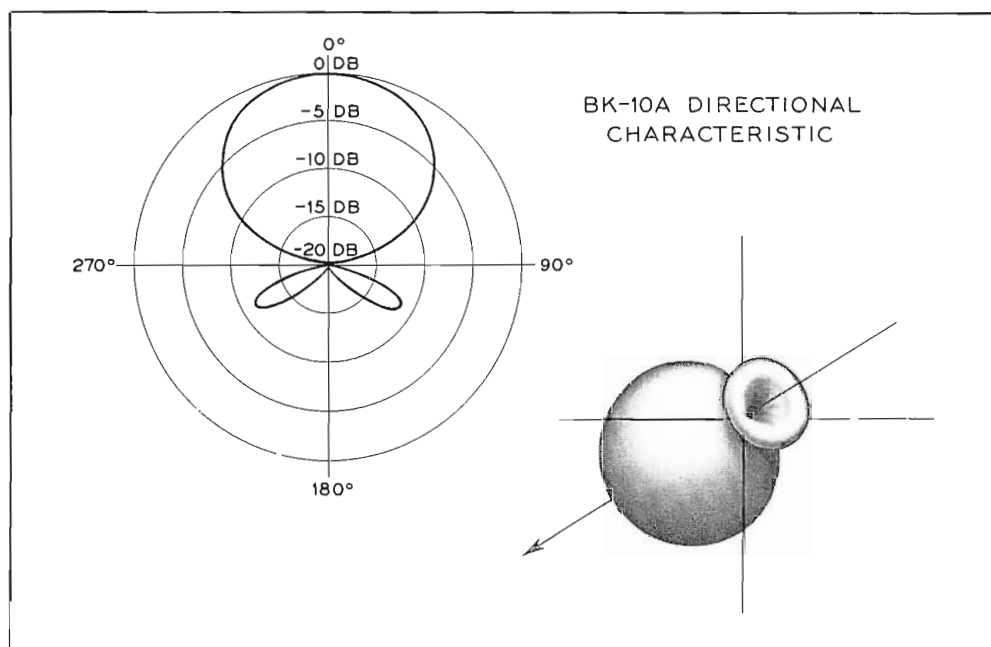

FIG. 1. At left, the conventional drawing shows the bigradient characteristics of the BK-10A. On the right, this bigradient characteristic is shown in a three dimensional configuration.

**An Ultra-Directional, High-Quality, Ribbon Microphone; Designed for TV Boom Use and Especially Effective in High-Noise Areas**



FIG. 2. This is the Type BK-10A Bigradient Uniaxial Microphone. Note center grill; the second microphone element is located here.

having 150 and 250 ohm unloaded input transformers, but may be changed at the terminal board to 40 ohms for use with 30 and 50 ohm input transformers.

**Feedback and Noise Reduction**

For situations where feedback from monitor speakers is a problem the BK-10A may be used successfully if the speaker is located in a null in the plane perpendicular to the axis or in the rear null. Thus, for the solution of feedback problems, the BK-10A is more versatile than either the velocity or cardioid microphones. The null plane at right angles to the microphone also serves another purpose when used in the television studio. The normal position of a TV boom microphone is overhead in front of the talent. In this position camera crew and cameras are approximately in the null plane. This means that for a cardioid type microphone, attenuation of direct sounds from camera and crew is only 6 db. but the BK-10A will attenuate these noises by 18 to 20 db. Both of these comparisons are made with respect to the performance of a nondirectional microphone.

**Mounting Noise Reduced**

The cable supplied with the microphone is 18" long and is designed to give a maximum attenuation of cable transmitted noises. The cable consists of tinsel cord conductors braided together. Cables of this type have served continuously for five years in television boom use without failure.

The mounting supplied with the BK-10A follows the modern styling of the microphone. It provides for all normal angles of

tilt encountered in television boom use. The mount is compact and does not detract from the performance in any manner.

The frequency response is shown in Fig. 3. No low-frequency compensation is included; the BK-10A was designed for use at distances greater than three feet as would be encountered in boom operation. Proximity of large obstacles may have a deleterious effect upon the directional characteristics in some cases. The output level is maintained at -55 dbm.

**Applications**

The "Ultra-Directional" characteristics, of the BK-10A, make it the ultimate for high-quality reproductions in those situations where premium performance is a must. The directional properties of the microphone will provide excellent noise rejection even under adverse conditions. The BK-10A is a superior acoustic tool that will find numerous applications in the television and radio broadcast fields, as well as in the recording and public address systems.

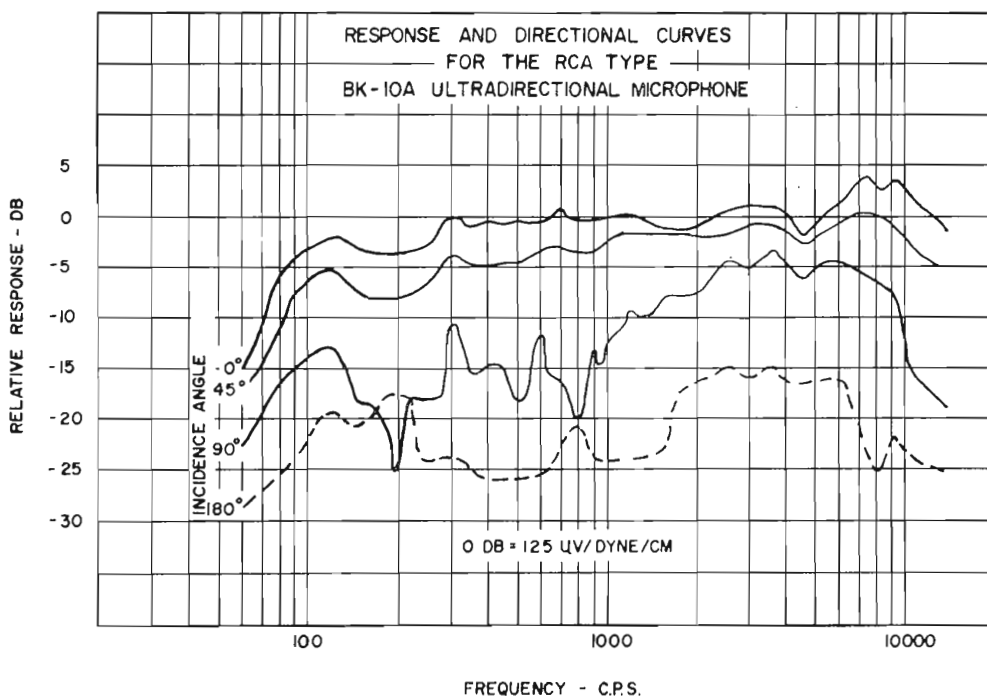

FIG. 3. The frequency response curves for the BK-10A are shown for various incidence angles of sound pickup.

# NEW 2-KW VHF TELEVISION TRANSMITTER TYPE TT-2BH

*A High-Band, Economical, Low-Power Transmitter for  
Medium-Coverage Applications and Standby Use*

*by H. E. SMALL, Broadcast and Television Engineering*

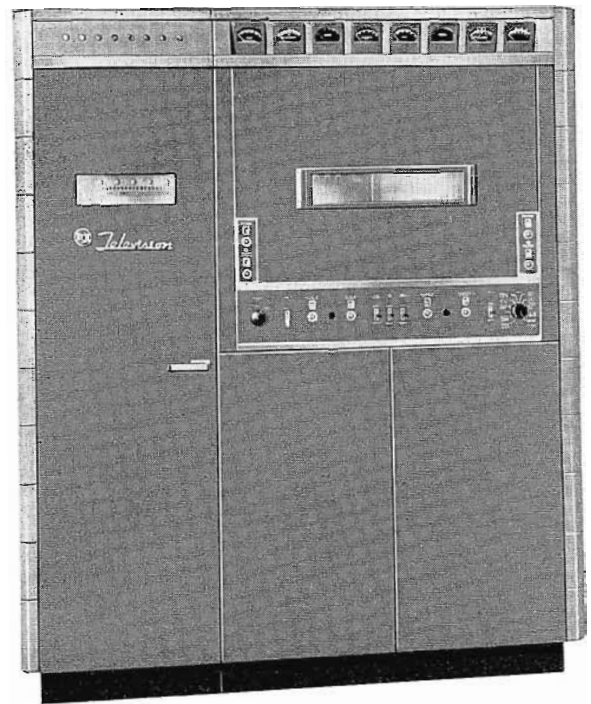

FIG. 1. Front view of new TT-2BH, 2 KW, television transmitter. Note sloping meter panels, and convenient placement of operating controls.

Space-saving cabinetry, provisions for remote control, fewer tube types, and built-in linearity correction for color TV, make the new TT-2BH 2-KW, high-band VHF television transmitter a compact, economical low-power unit. The TT-2BH is an ideal transmitter for the medium-coverage station or as a standby for the high-power station. The design is based on proven performance of the TT-2BL/6AL low-band transmitter; however, the TT-2BH has many exclusive features necessary for high-band operation.

## Distinctive Features

The TT-2BH has many features of which the following are outstanding:

1. New style cabinetry offers excellent accessibility to all components, and it allows a great saving in floor space.
2. The TT-2BH was designed to meet stringent color TV specifications. Built-in linearity correction can eliminate the need for a stabilizing amplifier at the transmitter site. Accurate intercarrier frequency control is used to get better color performance.
3. Only two tube types are used in the r-f stages following the exciter. These stages will tune to any of the high-

band VHF channels without the installation of frequency-determining components, and this ease of tuning is a feature that should win the acclaim of station personnel.

4. Complete overload protection is provided for all circuits. The circuit at fault can be readily detected by means of a row of indicating lights which are visible through the window in the control rack door.
5. A sloping illuminated meter panel at the top of the transmitter makes it easy to read the meters.
6. The temperature of all mercury vapor rectifier tubes is thermostatically controlled to permit operation at lower ambient temperatures.
7. Remote control provisions have been included in the design. (Although remote control has not yet been authorized for domestic television service, it is possible that it might be authorized within a few years.)

## Space Savings

The typical floor plan, shown in Fig. 2, indicates the small floor area required for the installation of a TT-2BH transmitter.

The size of the room indicated is not an absolute minimum, but is the recommended minimum to allow ample freedom of movement for personnel and test equipment. As can be seen in Fig. 2, no additional floor area is required for the harmonic filters, vestigial sideband filter or diplexer, since these units can all be suspended from the ceiling as indicated.

The rear of the transmitter enclosure can be placed directly against the wall since there are no components or access doors at the rear. All transmitter components are contained inside the enclosure, and they are accessible from an aisle directly behind the front line racks. All power-supply components are inside the enclosure and to the rear of the aisle; it is not necessary to encase any of the transformers, since they are behind an interlocked door. This effects a reduction in space requirements as well as improving accessibility.

If space in the operating room is very limited, the rectifier enclosure can be separated from the front line racks and placed in another room, or in the basement. In this event rear doors are then added to the control and r-f racks, and a front wall is added to the rectifier enclosure. A typical floor plan using this alternate arrange-

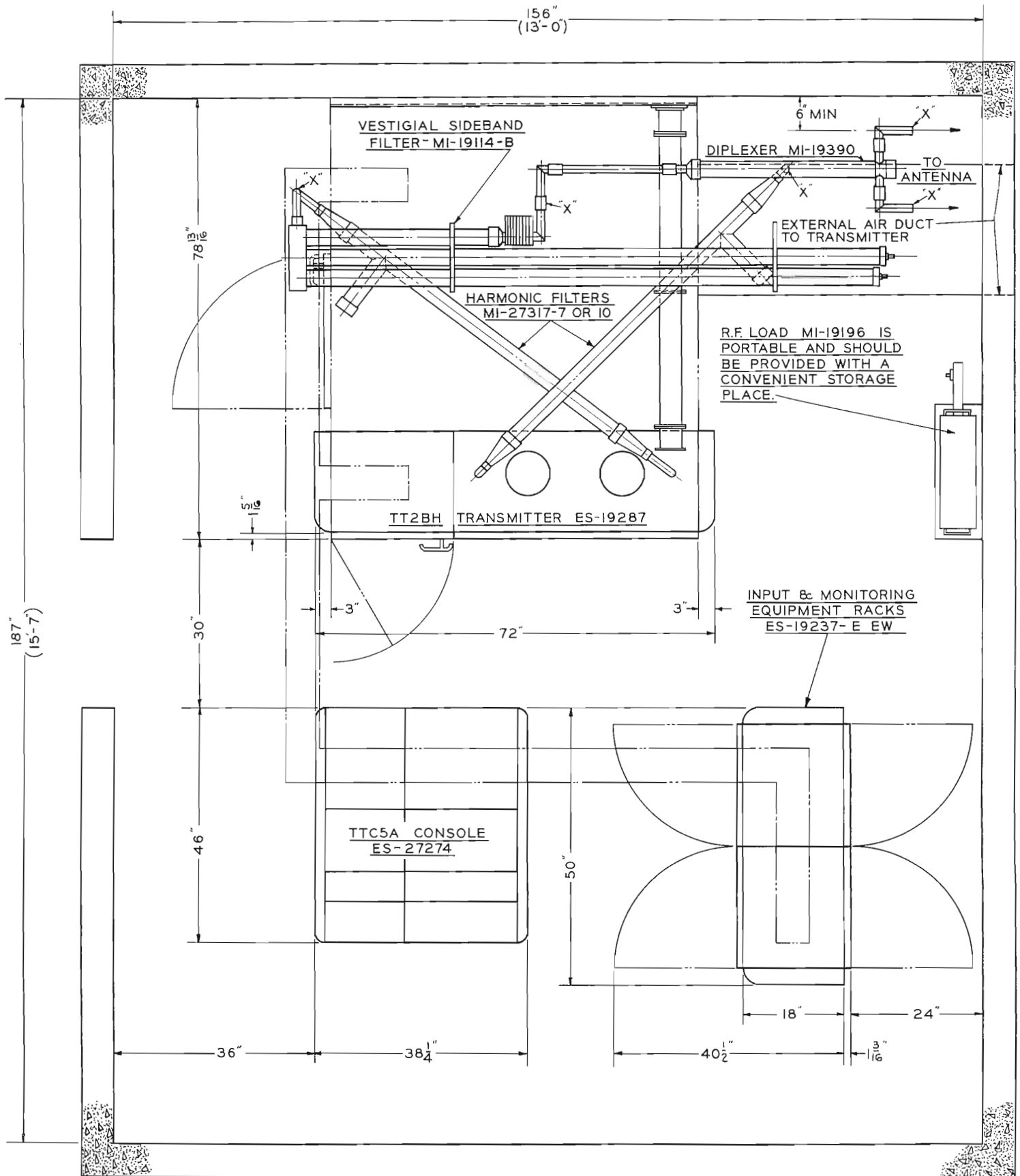

FIG. 2. Typical floor plan arrangement for the TT-2BH. The entire transmitter is only 72 inches wide and can be located in a small floor area. At points marked by "X," provisions should be made for connection of a dummy load for testing and tuning the TT-2BH.

FIG. 3. An alternate floor plan arrangement for the TT-2BH. In this case the vestigial sideband filter and diplexer locations are optional.

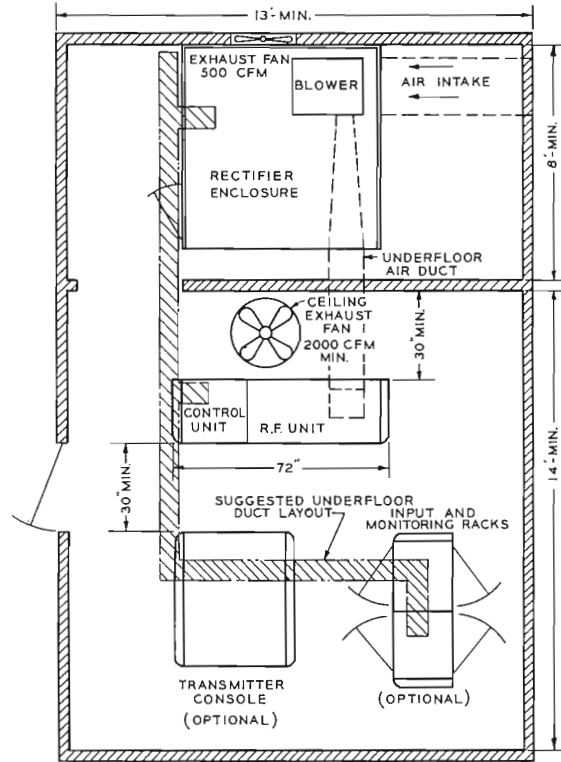

FIG. 4. Various possibilities in which the rectifier enclosure of the TT-2BH transmitter may be installed.

ment is shown in Fig. 3. Variations in the rectifier enclosure installation are shown in Fig. 4. The blower can also be mounted in the basement, by itself, if provisions are made for filtering the intake air.

#### Provisions for Remote Control

In addition to the thermostatically controlled heaters for the mercury vapor rectifier tubes to allow operation at temperatures as low as 0 degrees C, a thermostatically controlled blower cools the tubes at high ambient temperatures. For remote-control operation, a saving in heating of the transmitter room could be realized because of the lower permissible ambient temperature.

To make the TT-2BH transmitter completely controllable from a remote location, motor-driven controls are included for adjusting aural and visual excitation, as well as video gain and pedestal level to the visual modulated amplifier. Also, meter shunts with external terminals for all FCC required meters are included. Additional meter functions have been incorporated to

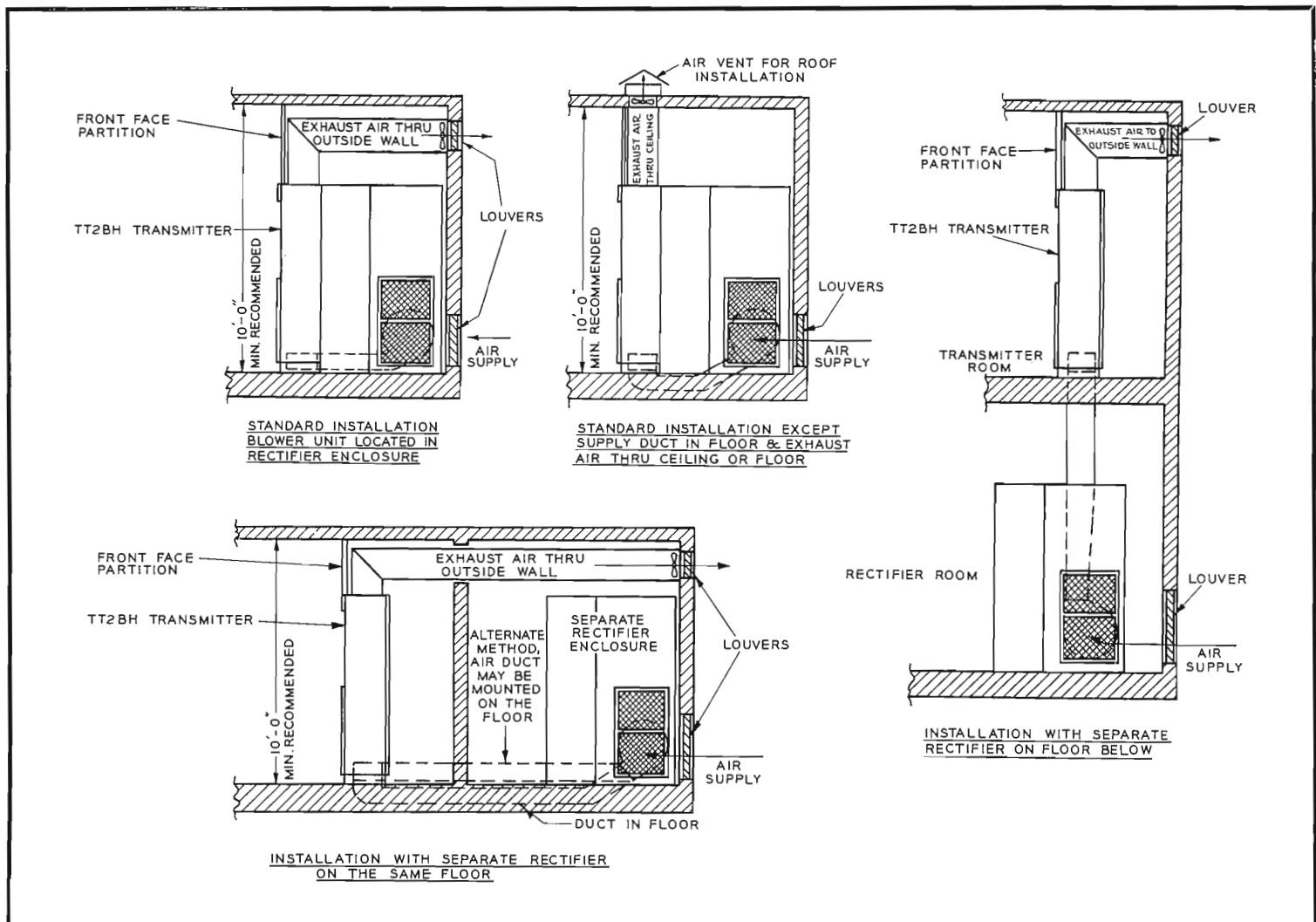

make possible the monitoring of all r-f stages following the exciter. It is also possible to switch visual crystal oscillators remotely. Even if the transmitter is not controlled from a remote location, these features can be utilized to control the transmitter from the console or other local positions.

**Proved Design**

A block diagram of the TT-2BH transmitter is shown in Fig. 5. The common aural and visual exciter is basically the same as the TT-2BL/6AL exciter; however, in the TT-2BH output frequencies are one third the aural and visual carrier frequencies. The 4.5 mc separation between the aural and visual carriers is very accurately maintained with an automatic frequency control circuit.<sup>1</sup> The visual modulator is on the same size chassis as the exciter, and it is mounted beside the exciter behind Dutch doors in the r-f rack. Both units are made to tilt outward for accessibility to components on the rear of

<sup>1</sup> "A New Aural and Visual TV Exciter," BROADCAST NEWS, Vol. 99, Feb., 1958.

FIG. 5. A block diagram of the TT-2BH 2-KW TV Transmitter.

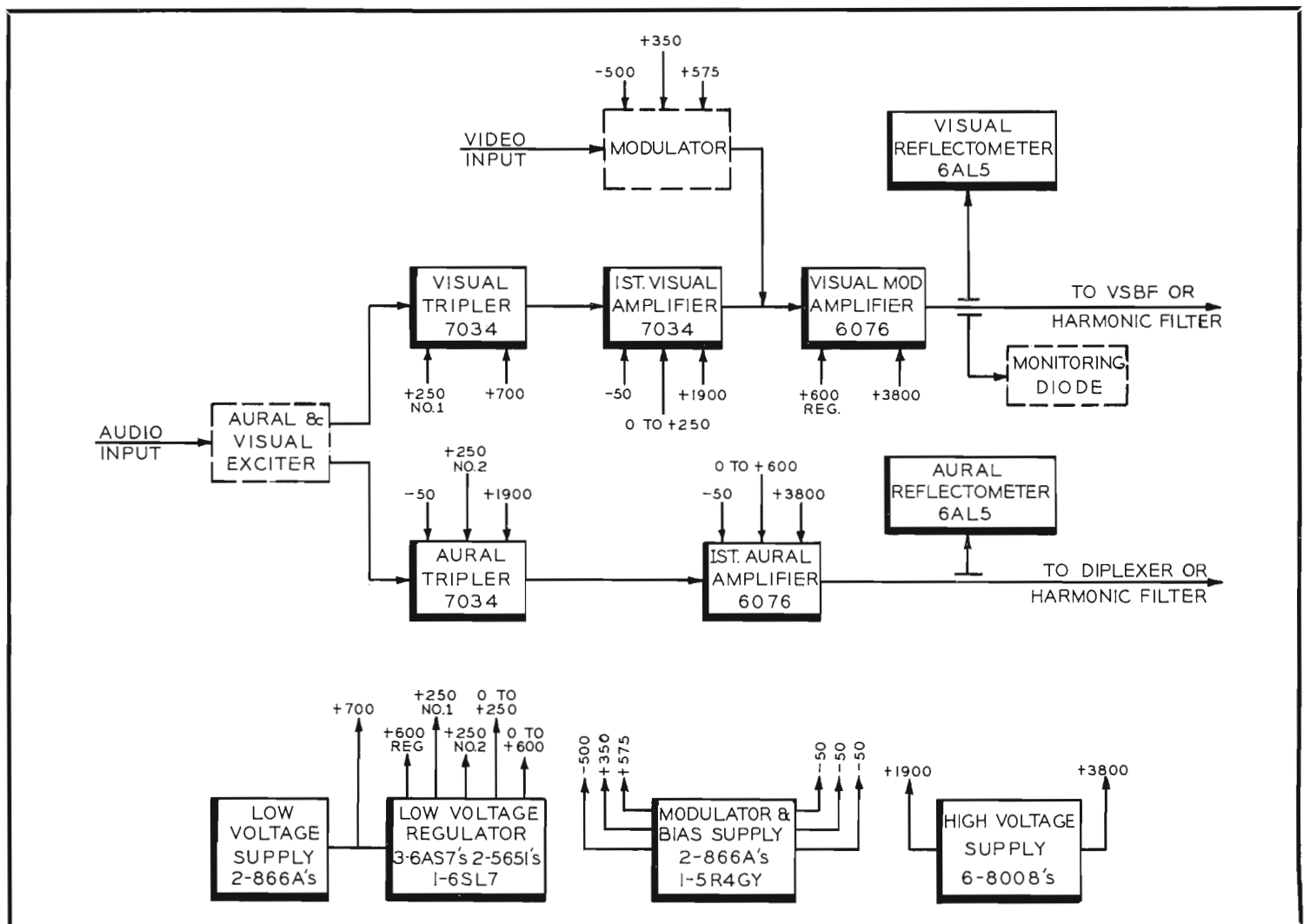

the chassis. Figure 6 shows the chassis in a lowered position for servicing. The units can be easily removed, without using tools, and placed on a bench for servicing if desirable.

#### Fewer Spare Tubes Required

The aural and visual r-f chains following the exciter use only two tube types, thus minimizing the number of spare tubes required. The first stage in each chain is a tripler using a type 7034 tube. The visual tripler drives a type 7034 class "C" amplifier which in turn drives the modulated amplifier. Both output stages employ type 6076 tubes. The aural output stage is a class "C" amplifier driven by the aural tripler. The r-f circuitry is simple and straightforward. All stages are single-ended using a minimum number of components, and are all easy to tune.

#### Only Four Power Supplies

Common power supplies for aural and visual stages have been employed to reduce the number of rectifier tubes and components. The 3800-volt, high-voltage supply is a three-phase, full-wave rectifier. A 1900-volt supply is also obtained by using three of the same rectifier tubes as a 3-phase, half-wave rectifier. The entire transmitter operates on only four d-c power supplies, and each is individually protected against overloads. The complete exciter power supply is contained on the exciter chassis.

This new design adds a high-channel, low-power transmitter to the RCA line of space-saving, VHF transmitters.<sup>2</sup> The new style of cabinetry has not only made possible a reduction in floor space requirements but, at the same time, has improved accessibility. The ease of tuning and the low cost of operation of the TT-2BH, along with remote control provisions are some of the outstanding features that make it an economical, low-power transmitter for medium-coverage stations.

<sup>2</sup> "Latest Development in VHF Television Transmitters." BROADCAST NEWS, Vol. No. 91, October, 1956.

FIG. 6. Note "Dutch door" design of TT-2BH transmitter. The modulator and exciter tilt out for ease of servicing.

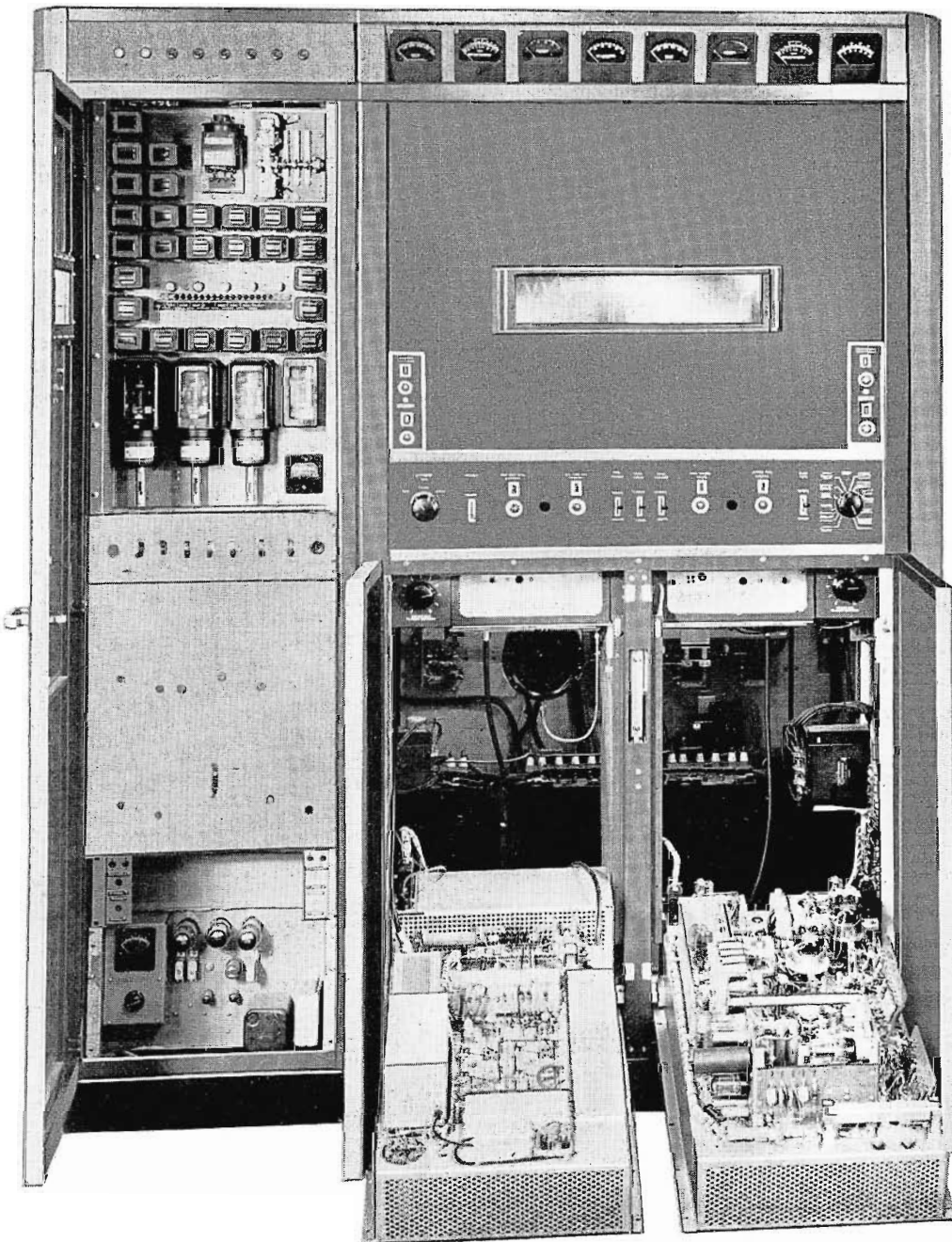



**B**enedict Gimbel, Jr., President and General Manager of radio stations WIP and WIP-FM, signed a contract on February 26, 1958, for an RCA Type BTA-5H Transmitter. With the purchase of this new 5000-watt transmitter, WIP plans to inaugurate a new high-fidelity concept in its programming.

Modern demands for high-quality sound in broadcasting are being felt everywhere and WIP is doing something to improve its position. Since first going on the air in Philadelphia in 1922, WIP has been keeping pace with the latest developments in the broadcasting art. This newest addition will enable WIP to offer its listening audience the best sound possible.

The 5000-watt, BTA-5H, transmitter will be installed at WIP's present transmitter site in Bellmawr, New Jersey. The transmitter now in use will be used for auxiliary operation. WIP was among the first stations to operate continuously and the present schedule is 24 hours a day, seven days a week. With this type of operating schedule only a highly reliable transmitter like the BTA-5H would offer the performance required and at the same time offer the finest in sound.

In today's highly competitive market WIP realizes the need for high fidelity in AM radio broadcasting. In its search for the best sounding and most reliable AM transmitter, the station has selected the BTA-5H. This will spell another success story for WIP.



FIG. 1. Benedict Gimbel, Jr., President and General Manager of radio stations WIP and WIP-FM, signs contract for new RCA Type BTA-5H, 5000-Watt Transmitter. RCA Broadcast Field Sales Representative A. W. Power (left), and WIP Technical Supervisor Clifford C. Harris look on.

# WIP GETS NEW 5-KW TRANSMITTER TYPE BTA-5H

*Philadelphia's Pioneer Voice  
Gets New and Improved Sound*

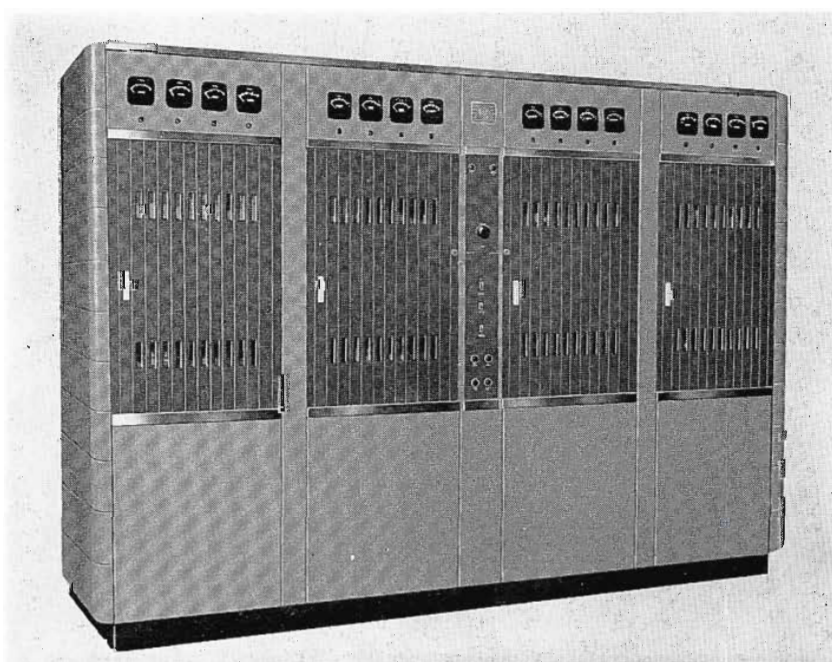

FIG. 2. This is the type of transmitter purchased by WIP, which will be installed at Bellmawr, New Jersey. The BTA-5H transmitter offers WIP the finest sound possible with minimum distortion and low-operating cost. RCA's bi-level modulation provides true high fidelity frequency response.

# UNIVERSAL COAXIAL TRANSMISSION LINE

*Exhibits Very Broadband Characteristics  
Covers Both VHF and UHF Channels  
Is Easier to Assemble  
and Assures a Lower VSWR*

by W. N. MOULE  
*Broadcast and Television Engineering*

After a study of experience gathered from hundreds of transmission line installations over the past several years, the Universal Transmission Line was developed to incorporate all possible improvements over the present lines. This new coaxial line is electrically capable of covering the UHF as well as the VHF channels (hence the term "Universal") at no increase in cost over comparable "VHF only" lines. The new line of universal coaxial transmission line is available in three sizes:  $3\frac{1}{8}$ -inch, 50-ohm line (MI-27791);  $6\frac{1}{8}$ -inch, 75-ohm line (MI-27792); and  $9\frac{3}{16}$ -inch, 75-ohm line (MI-27793). In addition, there is a complement of elbows, fittings and adapters.

## Mechanical Improvements

Improvements were made primarily with respect to making the installation "fool-proof" since errors in assembly were possible with previous types, especially if inexperienced personnel were making the installation. For example: the assembly of the bolted flange was time consuming, requiring 6 to 12 bolts, nuts and lockwashers to assemble. Pinching of the "O" ring could occur (unless extreme care was exercised) and this would result in poor flange contact, with high VSWR (voltage standing wave ratio). Occasionally complete disregard of centering pins cause similar results. The resulting faults were very difficult and expensive to locate on a long run of line because the contribution of one

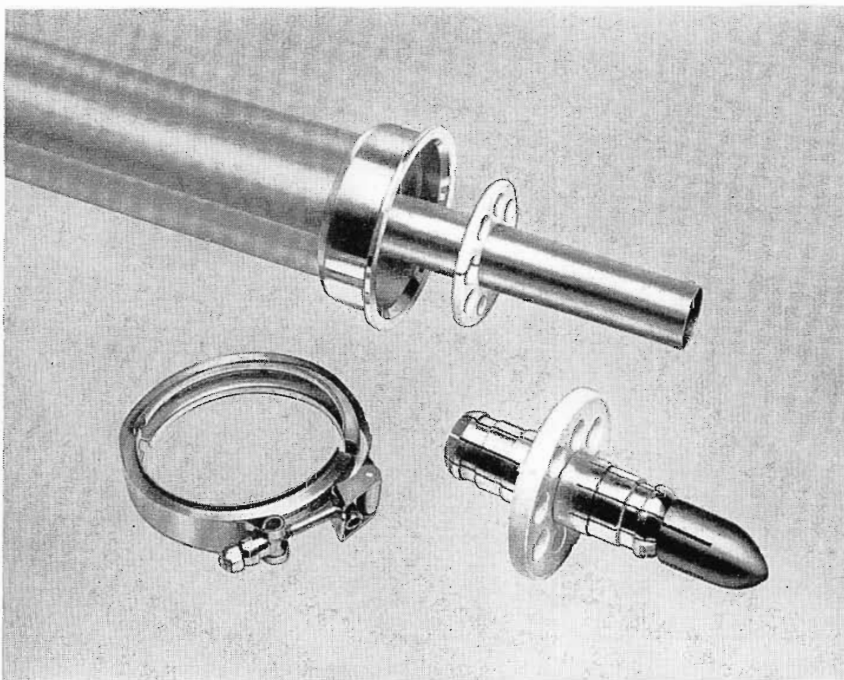

FIG. 1. A view of the  $3\frac{1}{8}$ -inch Universal Transmission Line showing inner conductor, support insulator, Marman clamp, and the inner conductor anchor insulator.

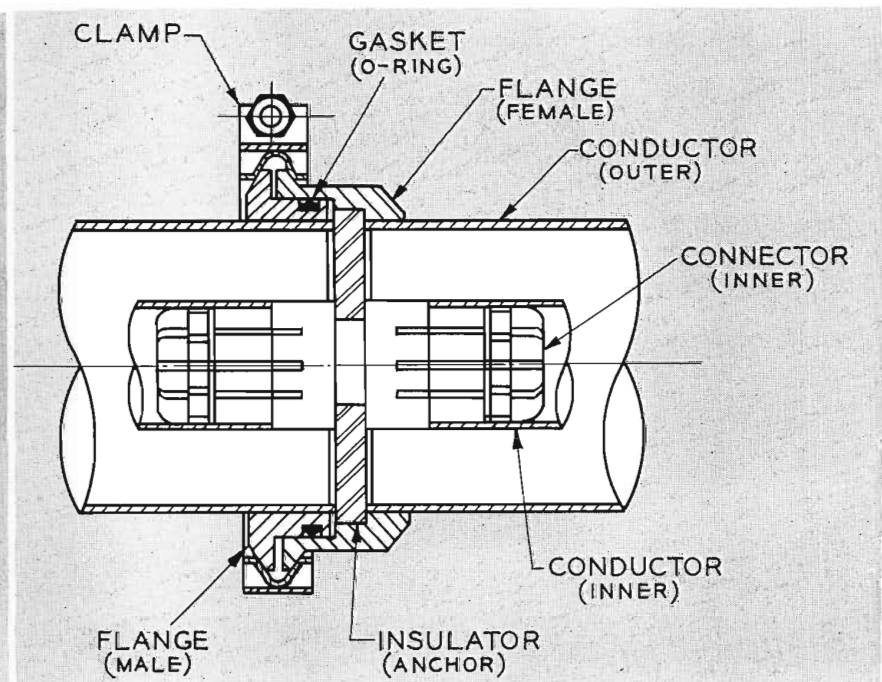

FIG. 2. This is a cutaway drawing showing the flanged connector assembly of the Universal Transmission Line.

such fault is small but the combination of several can result in a high VSWR causing ghosts, etc.

The problem of slow, tedious assembly was solved by using the new quick connect flange (see Figs. 1, 2, 3). Quick and positive assembly is obtained by using a Marman-type clamp, requiring only one or two bolts to tighten (depending on the line size). This flange assembly consists of a male and a female outer connector, which helps speed assembly by inherently providing a guide as the mating parts are pulled together. Thus, expensive rigging time is saved and proper assembly is assured.

Alignment of the two halves of the flange was greatly improved by making a sexed flange with mating concentric surfaces (see Fig. 2). Thus, it is impossible to assemble the flange misaligned.

Pinched "O" rings are avoided by holding the "O" ring captive in a deep groove on the male flange (see Figs. 2 and 3), minimizing the possibility of damage during assembly. Since the "O" ring is held between the cylindrical surfaces it is removed from the electrical contact surfaces so that even a damaged "O" ring cannot prevent good electrical contact in the flange.

#### Electrical Improvements

The important electrical improvement on the universal line is the increased band-

width of the compensation of the support insulators, thus resulting in lower VSWR over the whole VHF and UHF band. The method of improving the compensation of electrically transparent insulators was to put holes in the insulators to reduce the effective dielectric constant of the insulation. The reason for the increased bandwidth is as follows: The Teflon insulators supporting the inner conductor are of the electrically transparent type as shown in Fig. 4. In order to make the characteristic impedance of the section of line containing the support insulator equal to the characteristic impedance of the line, hence transparent, we must consider the following equation for the characteristic impedance of a lossless coaxial line:

$$Z_0 = \frac{138}{\sqrt{E}} \log \frac{D_1}{D_2} \quad (1)$$

where  $Z_0$  = characteristic impedance of the line

$E$  = dielectric constant of the medium (equals one for air)

$D_1$  = inside diameter of the outer conductor

$D_2$  = outside diameter of the inner conductor

It can be seen from the foregoing equation that the support insulator will lower the  $Z_0$  in the insulator section of line. To raise the characteristic impedance of this

section of line we can use the well known relation for lossless lines that:

$$Z_0 = \sqrt{\frac{L}{C}} \quad (2)$$

where  $L$  = the series inductance per unit length

$C$  = the shunt capacitance per unit length

Since we have increased  $C$  by the multiplying factor  $E$  we must, therefore, increase  $L$  so that the  $L$ -to- $C$  ratio is still the same as for the air part of the line. The series  $L$  is increased by undercutting the inner conductor (see Fig. 4) until the correct  $L$ -to- $C$  ratio is obtained. In the practical case the undercut portion of the inner conductor will have a characteristic impedance slightly greater than the air dielectric portion of the coaxial line to compensate for the additional step capacity caused by the sides of the undercut.<sup>1,2</sup> Thus an undercut insulator can be developed to have a characteristic impedance very nearly equal to the air dielectric portion of the coaxial line over a large frequency range.<sup>3,4</sup>

<sup>1</sup> "Equivalent Circuits for Discontinuities in Transmission Lines," Proc. I.R.E., Vol. 32, pp. 98-115, February, 1944.

<sup>2</sup> "Coaxial Line Discontinuities," Proc. I.R.E., Vol. 32, pp. 695-709, November, 1944.

<sup>3</sup> "A Coaxial Line Support for 0 to 4,000 Mc.," Proc. I.R.E., Vol. 37, pp. 94-98, Jan., 1949.

<sup>4</sup> "Notes on a Coaxial Line Bead," Proc. I.R.E., Vol. 37, pp. 1249, November, 1949.

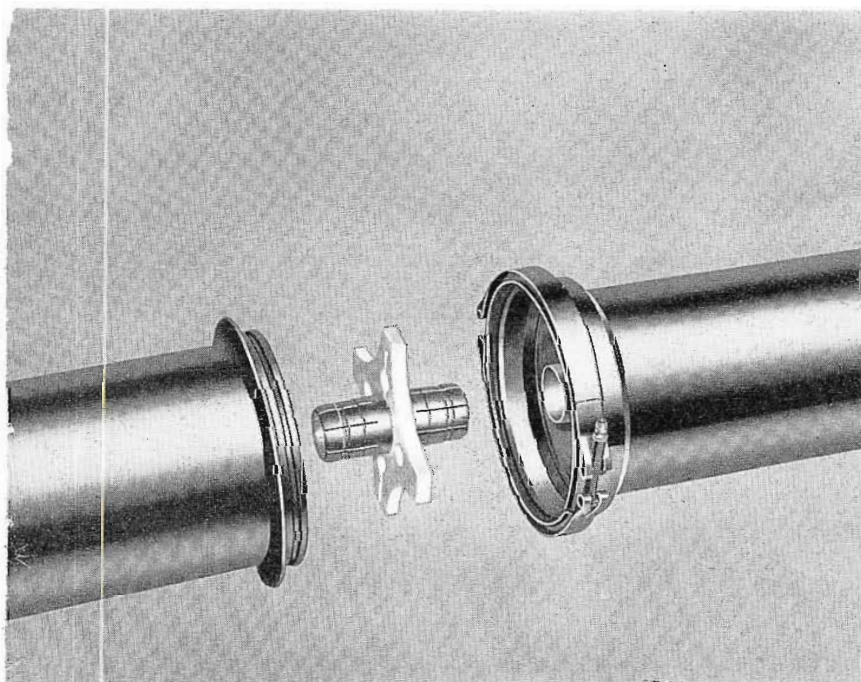

FIG. 3. An exploded view of the flange connector on a section of  $\frac{9}{16}$ -inch Universal Transmission Line.

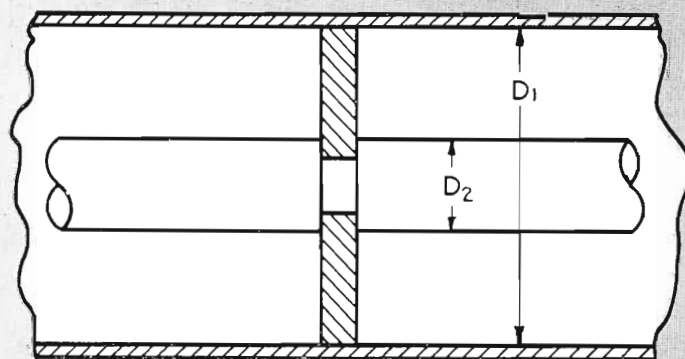

FIG. 4. Here is a cross section of an undercut insulator showing the spacing of inner and outer conductors.

FIG. 5. Attenuation curves for the three sizes of universal transmission lines are shown along with frequency limits, from 50 megacycles to the upper frequency limit of the lines.

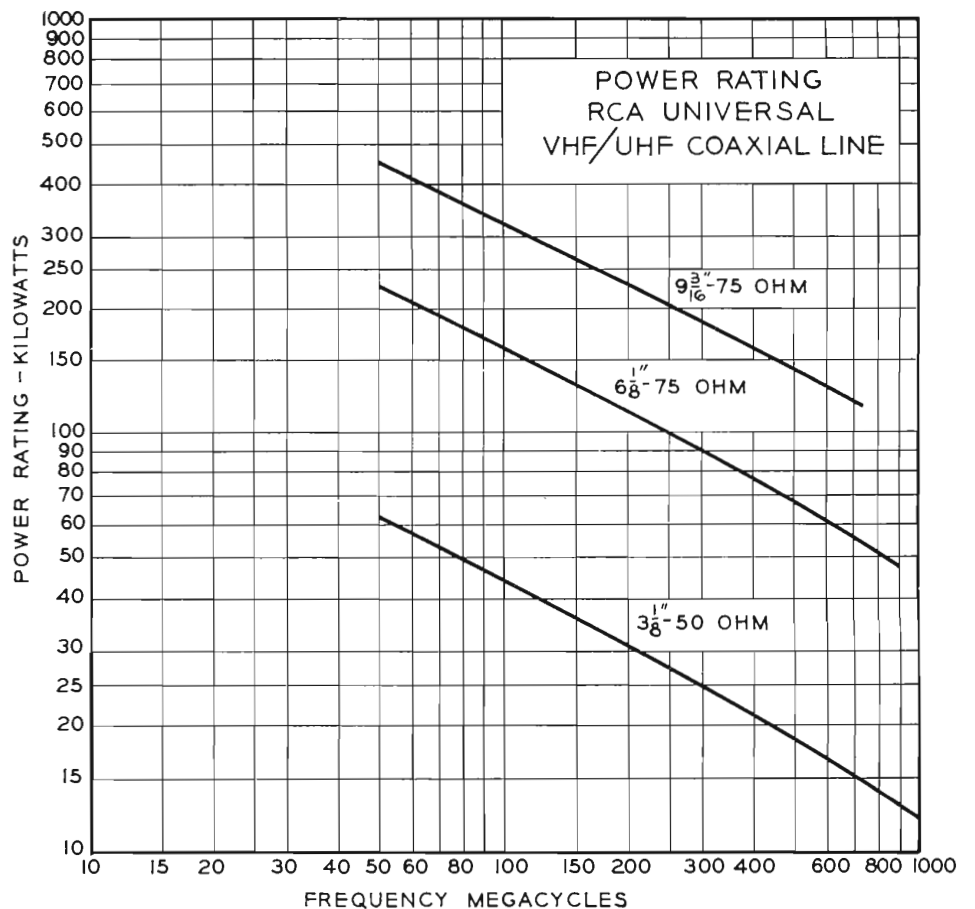
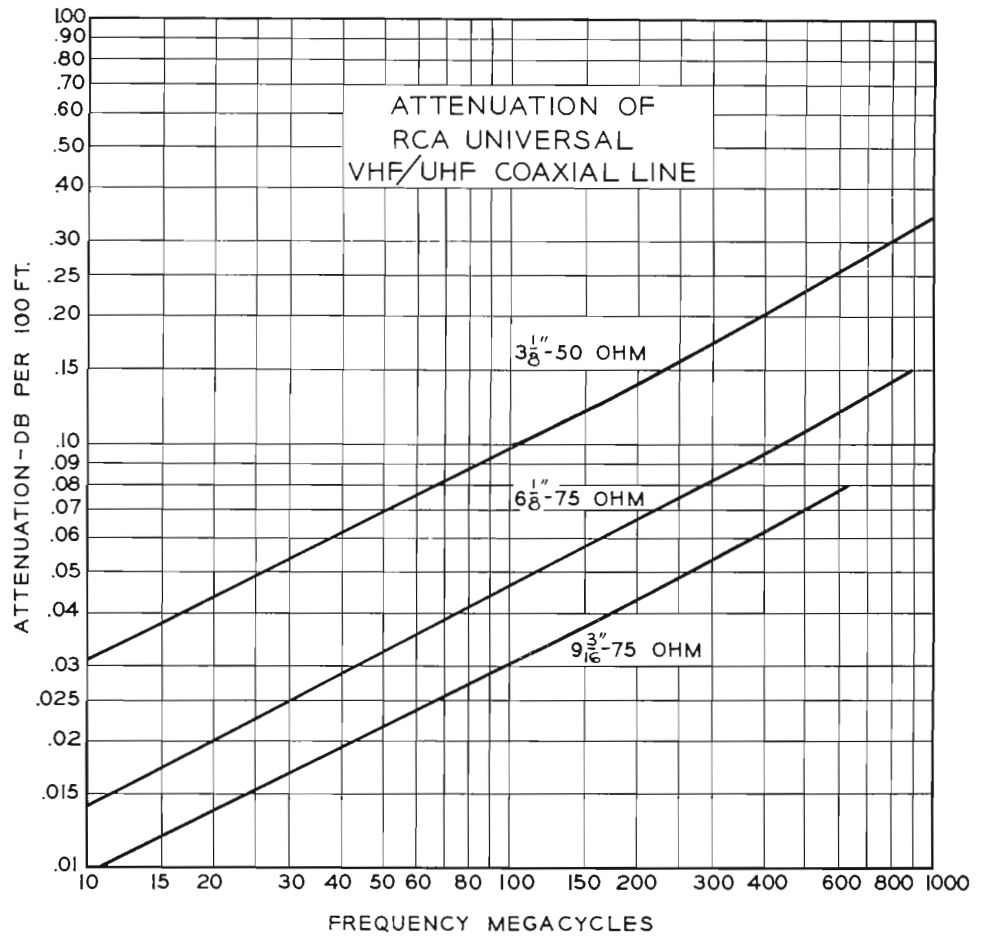

FIG. 6. The power ratings for universal transmission lines follow a descending curve as frequency is increased. The larger the size of the line the lower the attenuation per 100 feet.

Now the equivalent circuit of the transparent section is approximately that of a low pass "T" network operated considerably below cutoff. We can see by the following formula that  $f_c$  (cutoff frequency of the network) is increased if L and C are kept as small as possible:

$$f_c = \frac{1}{\pi\sqrt{LC}} \quad (3)$$

In the new universal lines, Teflon was used for the support insulator because of its low dielectric constant, approximately 2.08. The capacitance of the insulator was further reduced by putting large holes in the disc insulator so that the effective dielectric constant was considerably lowered (see Figs. 1 and 3). As can be seen from equation (2) reducing C also reduces the L required for compensation. Therefore, from equation (3) we see that the cutoff frequency is raised further above the operating band creating an almost perfect impedance match from channel 2 to 83.

#### Designed for 5 Megawatt UHF Installations

The universal lines come in three sizes, a standard  $3\frac{1}{8}$ -inch 50-ohm,  $6\frac{1}{8}$ -inch 75-ohm, and a new  $9\frac{3}{16}$ -inch 75-ohm size. The reason for choosing the 75-ohm impedance for the  $6\frac{1}{8}$ -inch size is to cover

all the UHF television channels without encountering the  $TE_{11}$  coaxial waveguide mode as would be the case with a 50-ohm impedance level. Also the 75-ohm impedance is nearly the optimum for minimum attenuation. The reason for developing the new  $9\frac{3}{16}$ -inch coaxial size was to provide a means of achieving a maximum effective radiated power (ERP) of 5 megawatts at UHF using a high gain UHF antenna (see attenuation and power rating curves Figs. 5 and 6). At the present state of the art, greater precision is obtainable from drawn copper tubing than from fabricated rectangular tubes as used in a waveguide system, hence a substantially lower VSWR is obtainable by using a coaxial system. The  $9\frac{3}{16}$ -inch line can be used through UHF channel 40.

#### Low VSWR Achieved

Figure 7 shows a VSWR versus frequency plot of an 800-ft. test run of  $3\frac{1}{8}$ -inch, 20-ft. sections of universal line. Note that the VSWR tends to peak up on this long run at those frequencies where the 20-ft. sections are an integral number of half wavelengths long. This occurs approximately every 24.5 megacycles. Because of manufacturing tolerances the compensation cannot be perfect and there will remain a small reflection at every insulator and flange which repeat in every line section.

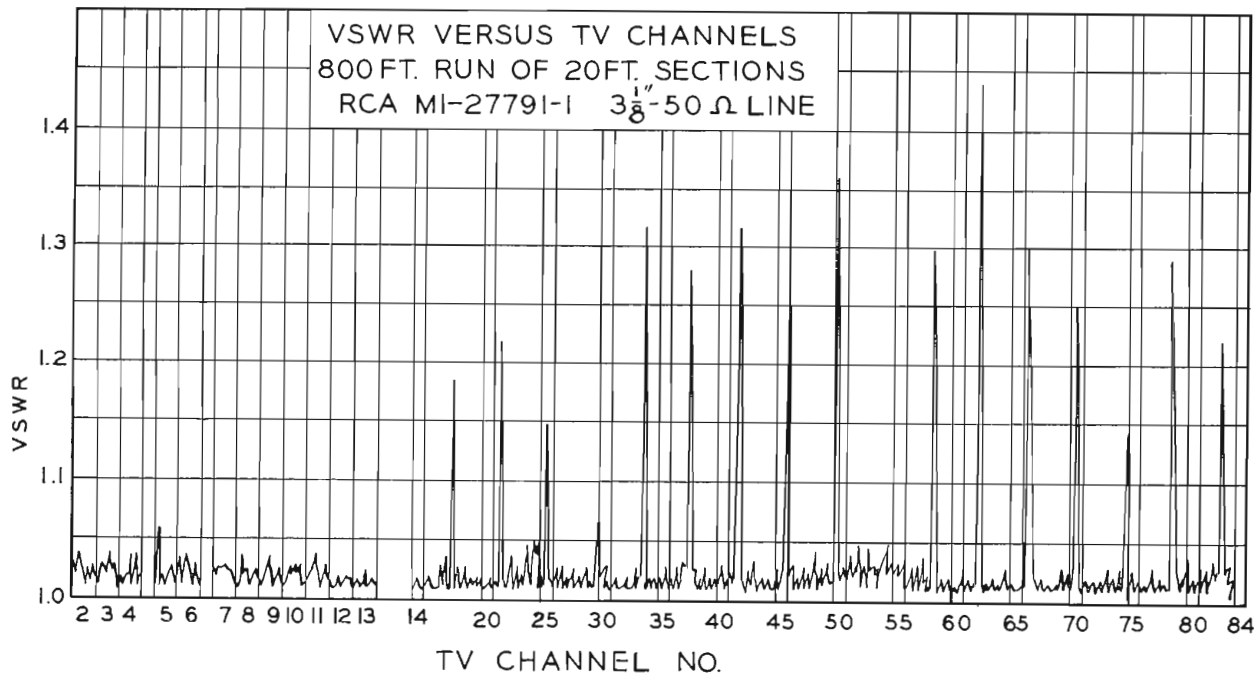

FIG. 7. The VSWR peaks on long runs of line at frequencies where 20-foot sections are an integral of half a wavelength. Spikes can be avoided by using 19½-foot sections.

**CHANNEL SELECTION  
TABLE OF LENGTHS**

CHANNELS REQUIRING 20-FOOT SECTIONS	2, 3
	4, 5
	6, 7
	8, 9
	11, 12
	13, 14
	15, 18
	19, 22
	23, 24
	27, 28
	31, 32
	35, 36
	39, 40
	43, 44
	47, 48
	51, 52
	56, 57
60, 61	
64, 65	
68, 69	
72, 73	
76, 77	
80, 81	
CHANNELS REQUIRING 19½-FOOT SECTIONS	10, 16
	17, 20
	21, 25
	26, 29
	30, 33
	34, 37
	38, 41
	42, 45
	46, 49
	50, 53
	54, 55
	58, 59
	62, 63
	66, 67
	70, 71
	74, 75
	78, 79
82, 83	

FIG. 8. Table shows channels that require 19½-foot and 20-foot sections to avoid a high VSWR.

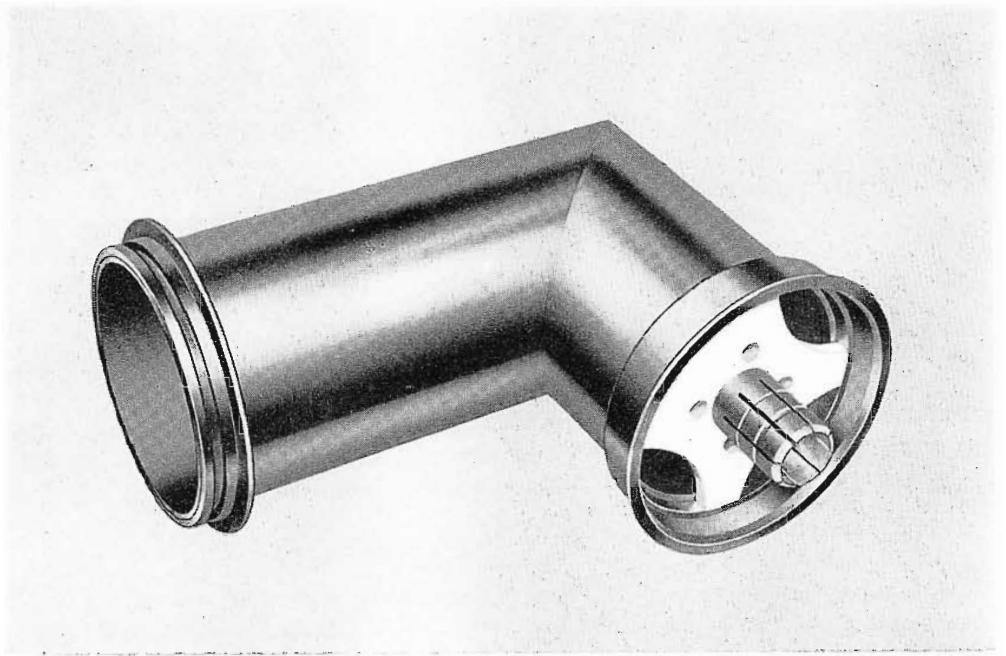

FIG. 9. A 90-degree miter elbow for 6 1/8-inch Universal Transmission Line is shown with its inner conductor and Teflon insulator.

In order to avoid this recurring VSWR spike, 19½-ft. sections are provided, as in previous RCA coaxial lines, for those channels which fall on the spikes caused by the 20-ft. sections. Figure 8 shows those channels requiring 20-ft. sections and those requiring 19½-ft. sections.

**Measured Attenuation and Power Rating**

The attenuation and power rating of the three sizes of lines are shown in Figs. 5 and 6. These are actual measured power ratings of the three and six-inch sizes to maximum safe operating temperature rise of the inner conductor. They represent the

steady state power required to heat the inner conductor to a 70 degrees C rise above a 50 degree C ambient temperature. The power curve for the 9 3/16-inch line is calculated from data based on extensive calculations and power measurements on the 3 1/8-inch and 6 1/8-inch sizes. The attenuation curves for the three line sizes are actual measured values on an 800-ft. test run for each line size.

A complete line of elbows (see Fig. 9) and fittings is provided for each line. Adapters are also available to connect the universal line to all conventional VHF and UHF flanged lines.

FIG. 10. The electrical and mechanical specifications for the RCA Universal Transmission Lines.

**SPECIFICATIONS**

**ELECTRICAL SPECIFICATIONS**

	3 1/8" Line MI-27791	6 1/8" Line MI-27792	9 3/16" Line MI-27793
Characteristic Impedance	50 ohms	75 ohms	75 ohms
Frequency Range	0-1000 mc	0-890 mc	0-632 mc
VSWR*	1.1/1 or less	1.1/1 or less	1.1/1 or less
Attenuation	See Fig. 5	See Fig. 5	See Fig. 5
Power Rating	See Fig. 6	See Fig. 6	See Fig. 6
Velocity of Propagation	99.8%	99.8%	99.8%

\* VSWR of transmission line run terminated in its characteristic impedance.

**MECHANICAL SPECIFICATIONS**

Standard Length (see table above)	20' and 19½'	20' and 19½'	20' and 19½'
<b>Outer Conductor:</b>			
O.D.	3.125"	6.125"	9.166"
I.D.	3.027"	5.981"	9.000"
<b>Inner Conductor:</b>			
O.D.	1.315"	1.711"	2.580"
I.D.	1.231"	1.661"	2.516"
<b>Weight (per section approx.)</b>	56 lbs.	130 lbs.	220 lbs.

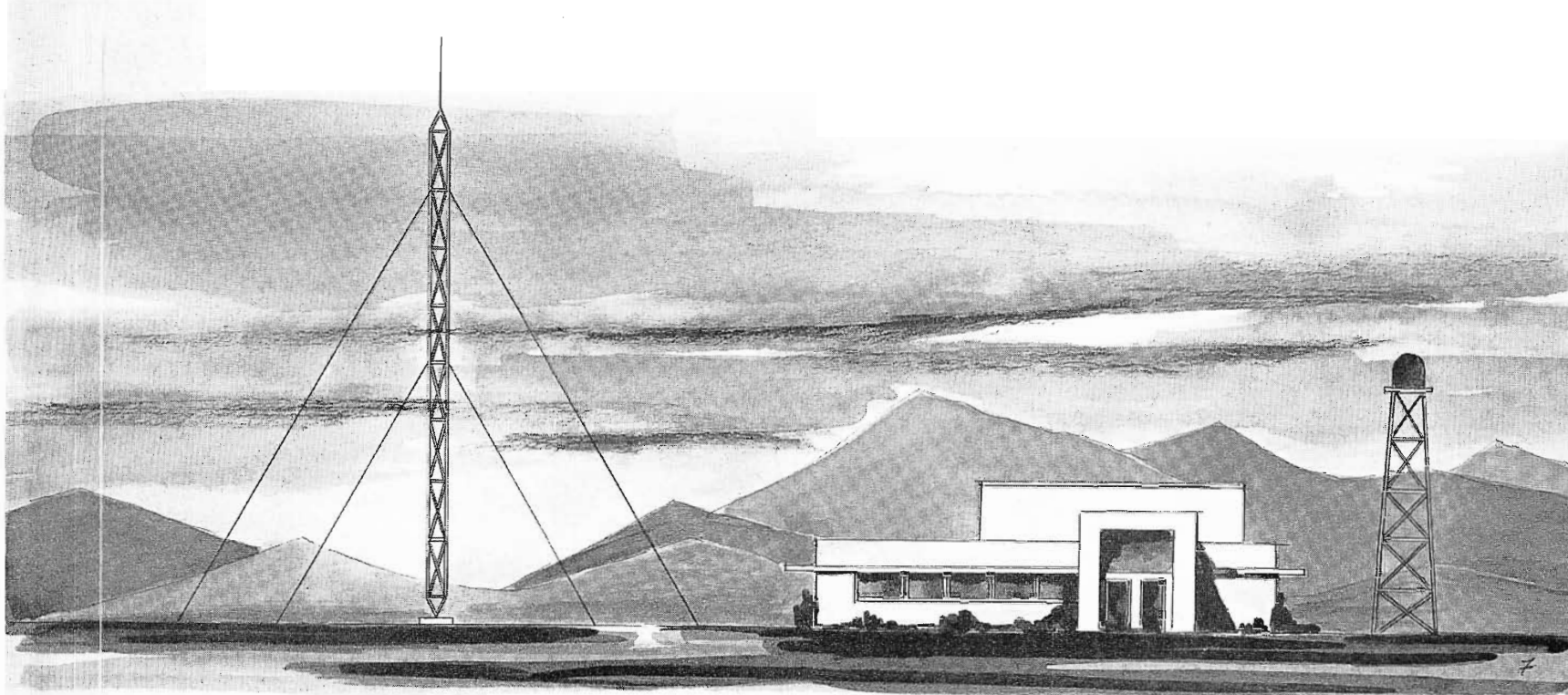

# GROUND WEATHER RADAR FOR BROADCAST STATIONS

*Provides Accurate Local Weather Information for Radio and TV  
Stations; Serves as Valuable Adjunct to Other Weather-Forecasting Services*

*by R. C. STRANG, Custom Aviation Engineering*

The accurate and timely transmission of complete local weather data has become an increasingly important responsibility of all radio and television stations and with this responsibility has come the need for improved local weather surveillance equipment. The RCA Ground Weather Radar is such an equipment, providing its operator the means for viewing and tracking storm fronts, thunderheads, squalls, and heavy cloud formations as well as other forms of precipitation and weather disturbances located up to 150 miles away. By proper interpretation of this radar it is possible to accurately forecast the time of arrival and relative magnitude of a weather disturbance in a specific area.

## **Equipment Description**

The RCA Ground Weather Radar system consists of the antenna, the receiver-transmitter, the indicator, the accessory unit and a control group. The antenna and receiver-transmitter are housed in a spe-

cially constructed radome which measures 5 feet in diameter and 6 feet in height. This radome contains provisions for a heater-blower unit to facilitate cooling and prevent condensation. The indicator, accessory unit and all controls necessary for operating the system are contained in a control console which is completely wired and ready for installation. A repeater indicator unit can be supplied when viewing is also desired at a remote or secondary location. The repeater indicator is identical to the indicator installed in the control console, and no internal circuit modifications are required in the radar system for its incorporation.

## **Operation**

This radar is very simple and straightforward in operation. External controls are located on each indicator as well as in the controls section of the console. Controls located on the indicator are for the purpose of varying the brilliance of the indicator

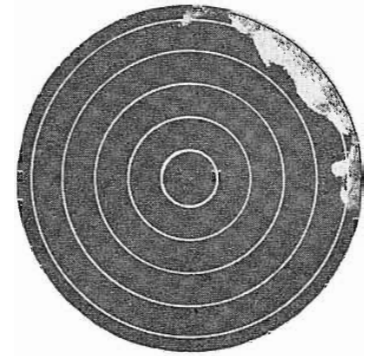
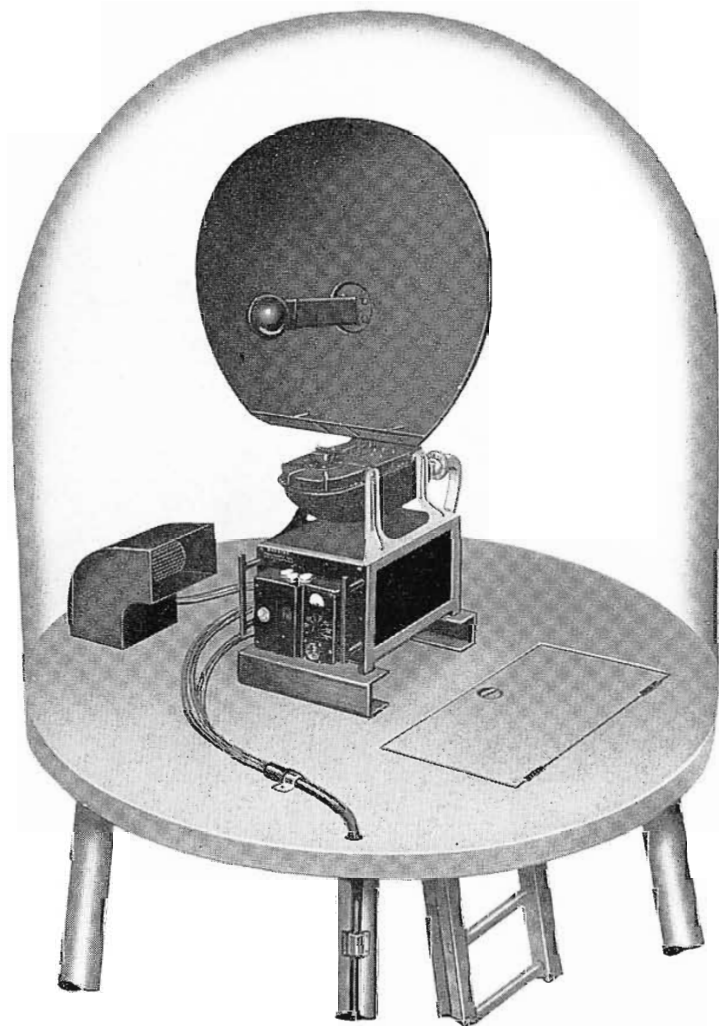

Normal Presentation  
50 Mile Range  
Time 12:00 Noon  
Storm Located at 47 Miles

FIG. 1. The radome is about five feet in diameter and six feet in height and may be mounted on a building or tower. Here is located antenna and receiver-transmitter. Radome also contains provisions for a blower-heater unit to prevent moisture condensation and facilitate cooling.

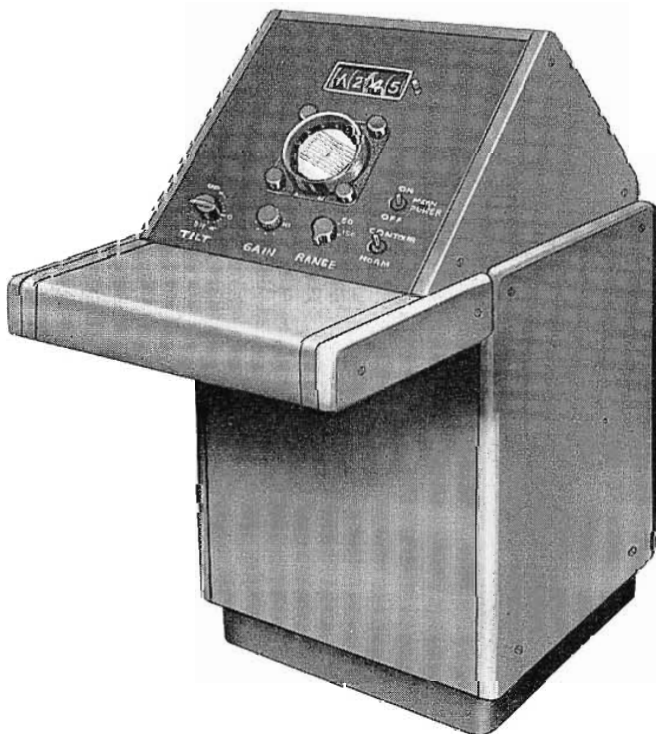

FIG. 2. The control console contains the indicator, accessory unit and all controls necessary for operating the system. Console may be remotely located in an office, studio or control room.

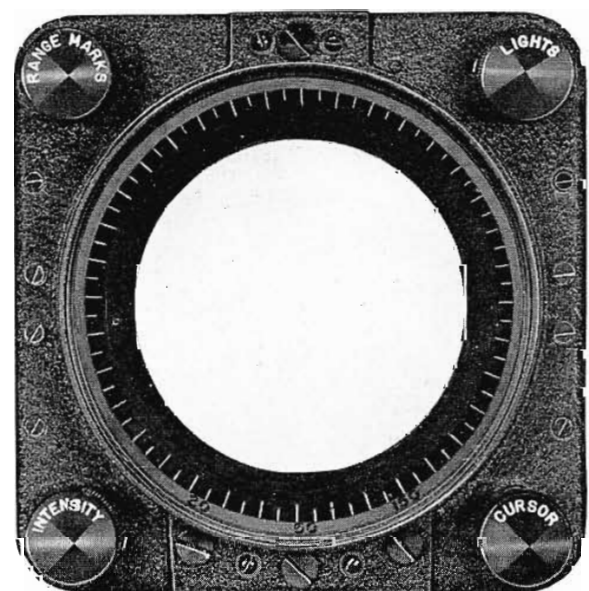

FIG. 3. Indicator unit mounted in control console gives operator continual weather surveillance. A repeater indicator unit can be supplied when viewing is desired at a remote or secondary location.



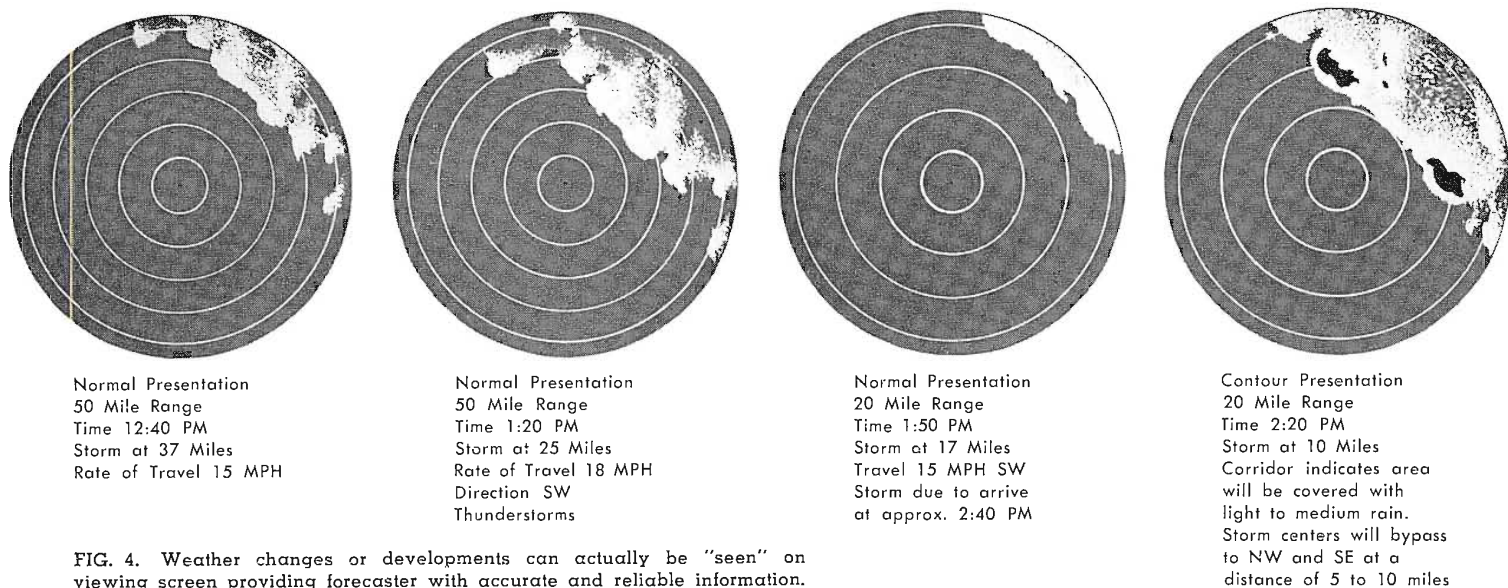

FIG. 4. Weather changes or developments can actually be "seen" on viewing screen providing forecaster with accurate and reliable information.

sweep and, therefore, all targets seen on the indicator screen, adjusting the intensity of the range marks, adjusting the indicator edge lighting, and a control with which it is possible to determine accurately the azimuth of any given target. Controls are provided on the console to energize the system, select the range, vary the receiver gain, elevate or depress the direction of the transmitted beam, and energize the Iso Contour circuitry.

#### How It Works

The basic principles of the system are those of an ultra-high frequency radar system consisting primarily of an antenna, pulse modulated transmitter, pulse reception receiver and an indicator. The transmitter feeds the antenna with pulses of energy modulated at a frequency of 5400 mc/s. These pulses are radiated on a line of sight transmission, reflected by a suitable target (e.g. precipitation) back to the same antenna, amplified by the receiver and displayed on the indicator. The travel time of these pulses is a measure of the distance from the radar system to the target. This distance is indicated by the separation of the target presentation from a fixed point in the center of the indicator face. The area and azimuth location of the targets is obtained by radiating the transmitted beam in the horizontal plane as the indicator sweep is rotated about its origin in synchronism with the antenna.

The azimuth of each target is thereby located by its angular deflection from the top of the indicator. The indicator display is, in effect then, a reduced scale plan view of the area scanned by the transmitter beam. Three range scales are provided, 0-20, 0-50, and 0-150 nautical miles. Electronic range marks can be superimposed on the display to occur at 5, 10 or 25 nautical mile intervals, according to the range in use.

#### Interpretation

The interpretation of relative storm intensities is facilitated by the use of Iso Contour circuitry. The results, as far as the target display is concerned, is the appearance of a dark center in an otherwise all light target. The size of this dark center relative to the size of the target accurately determines the degree of moisture present.

This radar system operates in the "C" frequency band at 5400 megacycles (5.5 centimeters wavelength) with a peak power output of 75 kw provided by a magnetron. The pulse width is 2.0 microseconds with a pulse repetition rate of 400 cps synchronized to the line frequency. The total radar system with one indicator requires approximately 850 VA of 115 volt, 380 to 420 cycle power and 30 watts of 27.5 volt DC. The antenna, equipped with a 34-inch reflector, has a 360 degree continuous scan rate at 15 rpm. It is possible to vary the direction of the approximately 4.5 degree

beam width from 0 degrees to 85 degrees with respect to the horizontal. The indicator display tube is 5 inches in diameter and gives a 360 degree, PPI type of presentation. The electronic range mark spacing is 5, 10 and 25 miles dependent upon the range that is employed.

#### Developed for Broadcasters

The advantages of radar for use in detecting and plotting weather disturbances was initially discovered as a detrimental by-product of early military bombing and navigation radars. Since World War II, large sums of money have been devoted to exploiting this characteristic and commercial airborne weather radar such as the RCA AVQ-10 and AVQ-50 Weather Radars has been the result. In recent years commercial airborne weather radar has made a very significant contribution to the safety and reliability in the operation of all major airlines and other members of the air transport industry. Partially as a result of the enthusiastic acceptance and proof of radar as a weather surveillance instrument in the air transport industry, it is now possible to provide a weather radar system specifically configured to meet the needs of the ground based operator at a cost consistent with commercial radio and television station requirements.

NOTE: For more information write to: RCA Broadcast and Television Equipment, Camden, N. J.

GETTING THE MOST FROM



**Good Films are  
Only HALF the story**

If you have complete system equipment to provide showmanship in your film programming, you'll be ready for bigger film profits. That's why it's a good idea to take a long look at your station's film room facilities before you invest a lot of money in films.

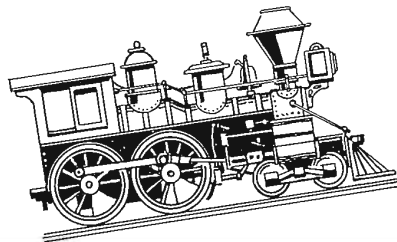

P. S.

**HOW LONG SINCE  
YOUR STATION'S  
FILM ROOM  
WAS MODERNIZED?**

YOUR FILM DOLLAR...

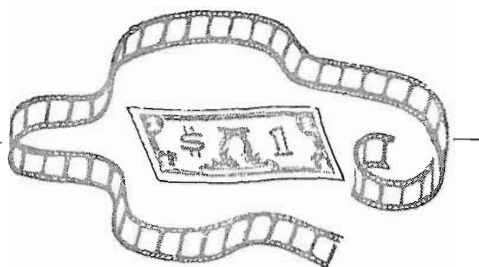

## How an RCA Film System Will Enable You to Spark and Hold Viewer Interest

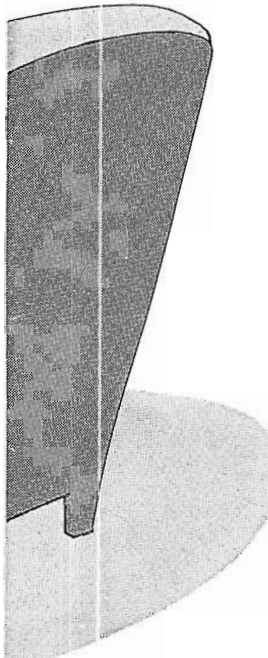

Here's how one of the most successful users of film shows gets excellent results. He employs several carefully planned steps made possible by the use of an extremely versatile film system. First, the program starts with a 20-sec. film commercial followed by a 10-sec. VSI—fading to a 30-sec. film teaser strip. The feature is then announced with a super-imposed “presentation” slide with record music. Feature is begun and film commercials are inserted at appropriate times to the end of the showing. This kind of expert programming that sustains audience interest is only possible with the proper combination of film equipment.

You have creative people who can do a similar job for you if given the right tools. An RCA Film System will provide them with these tools. It will enable you to offer a variety of film presentation formats for sparking and sustaining program interest. It will also help you prepare for future expansion.

Lack of long-range planning will obsolete equipment before its time . . . leave you unprepared for color. Investigate the quality and cost-saving of an RCA Film System—we'll be glad to help you check at typical stations. And ask the RCA Broadcast Representative to show you our latest film literature.

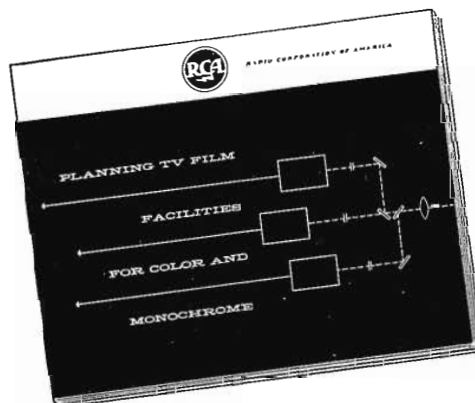

Tmk(s) ©

**RADIO CORPORATION of AMERICA**

BROADCAST AND TELEVISION EQUIPMENT

CAMDEN, N. J.

In Canada: RCA VICTOR Company Ltd., Montreal

# A new standard of performance for color television systems... The **RCA TM-21** Color Monitor

This new color control monitor is a reference standard for evaluating the quality of color television pictures from any source. Providing the most precise and brilliant color picture available . . . this new monitor accurately reproduces the scene *as the camera sees it*.

**QUALITY CONTROL OF COLOR PROGRAMMING**—The TM-21 is used in Color Camera Chains, Switching Systems, Master Control and Transmitting Control for monitoring color picture quality. It is the basic instrument for checking registration, shading and deflection linearity . . . color fidelity of the entire TV system . . . chroma to monochrome ratio . . . color phase or hue adjustments.

**BEST POSSIBLE COLOR**—When used to display color pictures in clients' rooms and executive offices, the TM-21 lets the station put its "best color foot forward." Clients will be impressed by the bright, high definition picture.

**COLOR ACCURACY AIDS PROGRAM PRODUCTION**—Production departments can use the new monitor for accurate continuity control of color programming. Producers and directors will get a true color picture of what's happening on the set. Costume and background colors can be seen in proper relationship. Lighting can be accurately evaluated, production aided.

**SIMPLIFIED MONITOR ALIGNMENT**—Initial adjustment is extremely simple. Built-in test switch reduces set-up time to minutes. Screen grid selector switch provides quick viewing of primary colors.

**LONG-TIME STABILITY**—Once set up, monitor adjustments "hold." Extra stability has been designed into brightness, contrast, decoder, convergence, and linearity circuits.

---

Get maximum return from your color TV investment! Ask your RCA Broadcast and Television representative for further information on the new TM-21 Color Monitor. In Canada: Write RCA VICTOR Company Limited, Montreal.



## Check these additional technical features:

- Feedback techniques and precision components provide long-term stability.
- Automatic brightness tracking for color balance.
- Convergence circuits designed for rapid setup.
- DC restoration at black level, stabilized by feedback.
- Stabilized diode demodulators.
- All components and tubes easily accessible.
- Automatic wide-band operation during monochrome picture intervals.
- Stabilized black level shows effects of pedestal adjustments, aids close control of color in picture low-lights.



Tmk(s) ®

**RADIO CORPORATION of AMERICA**

BROADCAST AND TELEVISION EQUIPMENT

CAMDEN, N. J.

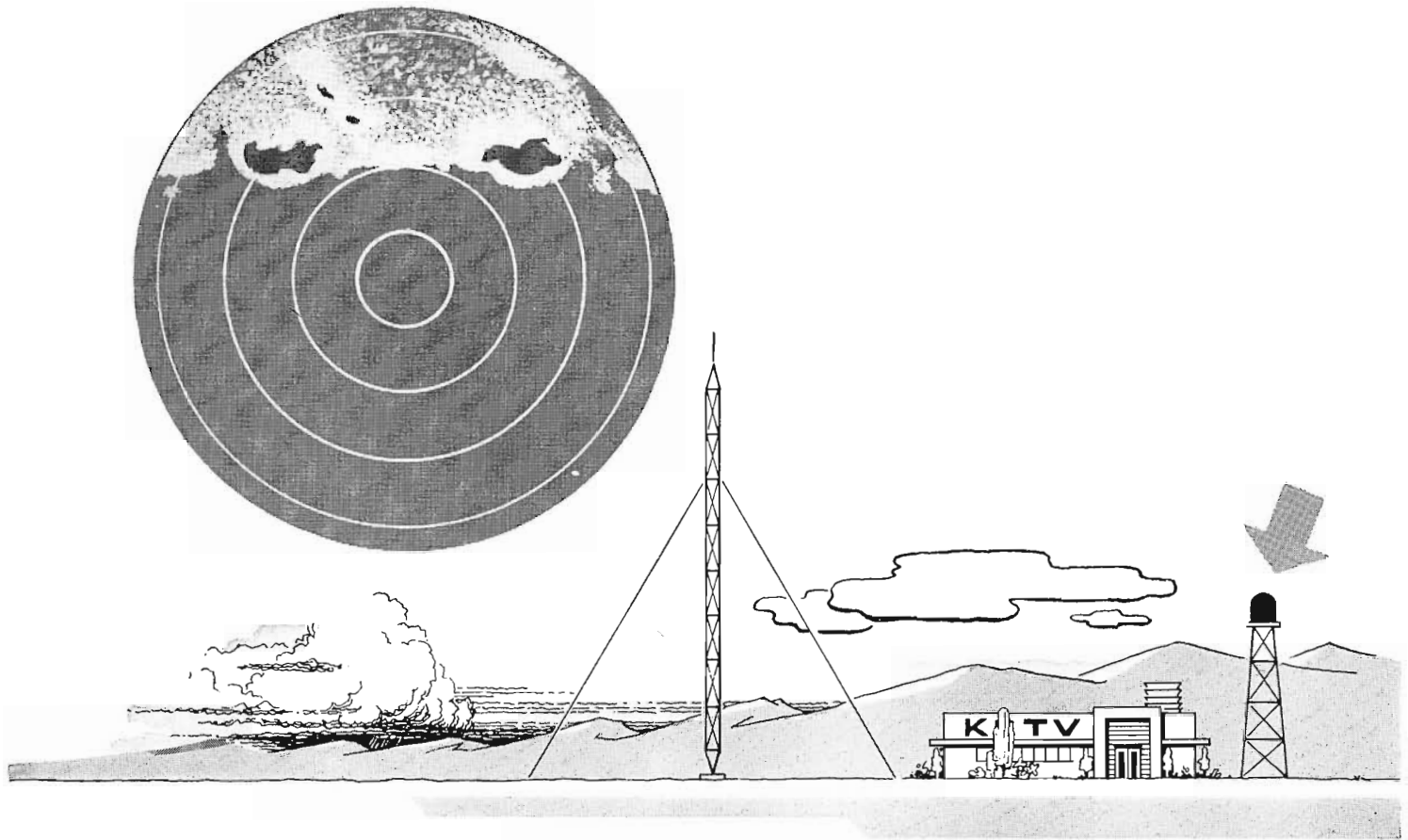

## A NEW PUBLIC SERVICE FOR TV AND RADIO STATIONS

The transmission of accurate local weather information from TV and Radio stations can prove to be invaluable as an adjunct to other general weather forecasting services. Many agricultural, commercial, and industrial projects, as well as public activities, are seriously affected by weather. In the capacity of rendering a public service, considerable interests can be generated by enterpris-

ing broadcasting stations with accurate and timely reporting of local weather conditions. The promotional advantages possible with RCA's Ground Weather Radar are unlimited.

*See your RCA Broadcast Representative for complete information about the RCA Ground Weather Radar.*

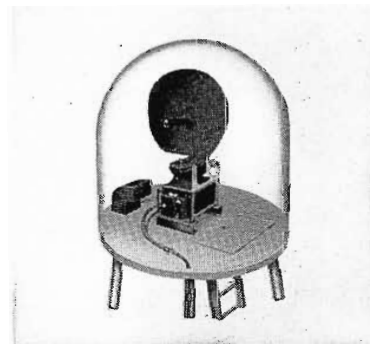

Tmk(s) ©

**RADIO CORPORATION of AMERICA**

Broadcast & Television Equipment

Camden, N. J.

## Planning a Radio Station?

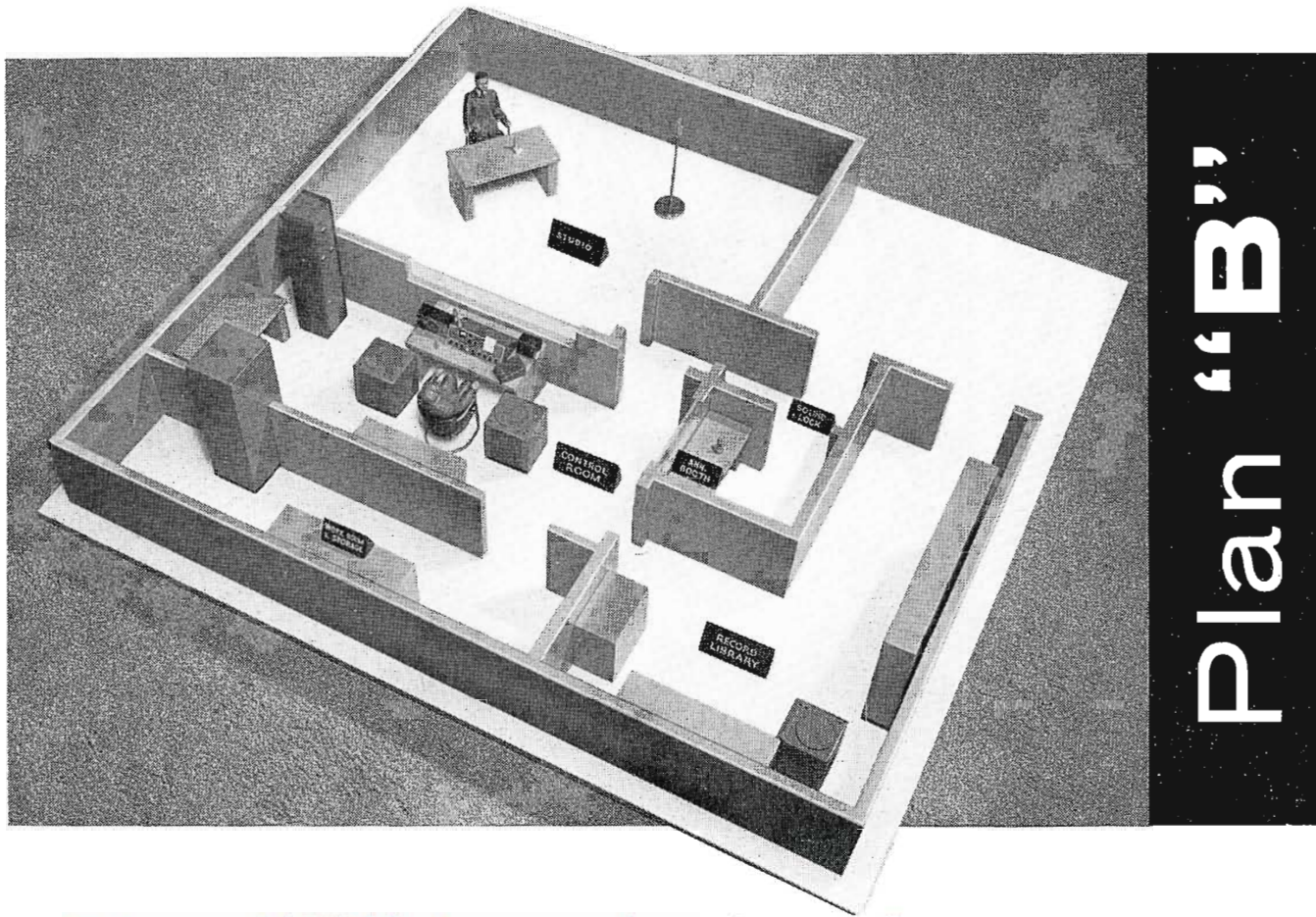

Plan "B"

## Plan "B" is a design for a medium-size station!

This plan fulfills all of the requirements for a low-cost, community-type radio station. It provides space and facilities for handling a very diversified program schedule. It incorporates technical features that make for adequate, yet economical operation. It is just one of three basic plans that can be modified to meet your needs exactly.

Plan "B" differs from the minimum investment design (Plan "A") by including a more spacious studio, an announce booth and a record library. It provides for expanded programming to include the origination of a fairly substantial live studio

show. With the announce booth serving as another origination point, it becomes very convenient to record announcements and other program material while on the air.

The plan offers many other features which are discussed at length in a new brochure, along with general planning considerations for the entire radio system. Building layouts, together with a discussion of equipment requirements and current trends, are also offered in the new brochure. For your free copy, write to RCA, Department C-22, Building 15-1, Camden, N. J. In Canada: RCA VICTOR Company Limited, Montreal.

**RCA** . . . *your first source of help in station planning*



Times, Inc.

**RADIO CORPORATION of AMERICA**

BROADCAST AND TELEVISION EQUIPMENT

CAMDEN, N. J.

Waveform-Oscilloscope Pattern Showing Signal Output and Uniform Sensitivity of the RCA-7038.

RCA-7038 Vidicon Without Side Tip (tube shown actual size).

FOR NEW TV-CAMERA DESIGNS

*New, Improved*

*Vidicon*

*...with much higher effective sensitivity*

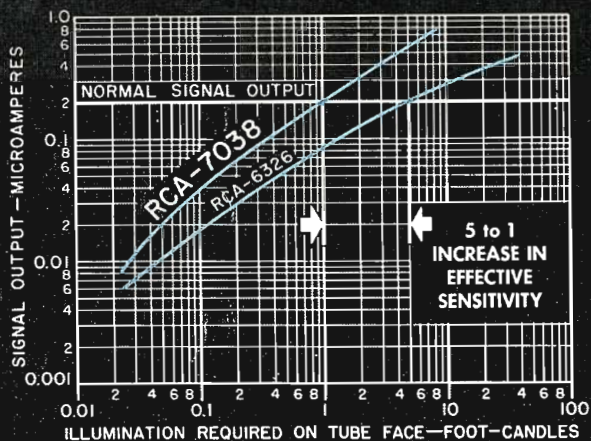

RCA-7038 Provides Higher Effective Sensitivity in New Camera Design.

Already being considered for new compact camera designs, RCA-7038 opens new possibilities in live and film pick-up camera techniques matched by no other Vidicon.

Here is a new Vidicon that can deliver broadcast-quality pictures—with as little as 1 foot-candle of illumination on its faceplate. An improved photolayer is capable of providing uniform sensitivity—over the entire scanned area. All “front-end” parts are non-magnetic to facilitate registration in three-vidicon color TV cameras.

RCA-7038 utilizes a 750-mesh screen. It has a resolution capability of 600 lines, and a spectral response covering the entire visible spectrum.

For a bulletin containing technical data and application information on the RCA-7038, write RCA Commercial Engineering, Section C-12-0, Harrison, N. J.



**RADIO CORPORATION OF AMERICA**

Electron Tube Division

Harrison, N. J.